

Technical Manual

Glassfront Beverage Vender

Models DN 55##, DN54##, DN 35##, DN2145

First Production 0001-8000BW (April 1, 1998)

Energy Star Production 0001-8376CC (August 24, 2004)



**Operation
Service
Parts
Troubleshooting
Manual**

Manufactured by



Dixie-Narco, Inc.
P.O. Drawer 719
Williston, SC 29853-0719
803-266-5001
fax: 803-266-5049
Visit us on the web: www.dixienarco.com

803,902,680.51

Table of Contents

GENERAL INFORMATION.....	4
Vender Safety Precautions	4
Product Identification	4
Physical Characteristics	4
INSTALLATION & SETUP	4 - 9
Receiving Inspection	4
Unpacking The Vender.....	5
Electrical Requirements	5
Ground The Vender	5
Installation & Setup Instructions	5 - 6
Placing the Vender On Location.....	6
Leveling the Vender.....	6
Spacing the Vender	6 - 7
Installing Labels & Flavor Cards.....	7
Coin Changers And Other Accessories	7
Set Temperature Control.....	7 - 8
Loading the Vender.....	8
Loading the Coin Changer.....	8
Power Distribution Box	8
Vending Machine Controller (VMC).....	8
Keypad	8
Digital Display	8
Refrigeration System	8 - 9
Shelf Assembly.....	9
Shelf Stabilizer	9
Gate Assembly	9
Slide / Pusher Assembly	9
PROGRAMMING.....	10 - 23
General	10
External Display Items	10
Normal Operation Messages	10
Initial Programming.....	11 - 12
Quick Reference Menu Items	13
Service Mode	14 - 16
Test Mode	16 - 19
Setup Mode.....	19 - 21
Setup Mode 2.....	21 - 23
GENERAL MAINTENANCE	24 - 25
Power	24
Cleaning	24
Eprom Replacement	25
MAJOR COMPONENT DESCRIPTION	26 - 27
AC Distribution Box / Refrigeration DN55##/54##/2145.....	26
AC Distribution Box / Refrigeration Unit DN35##	27
ELECTRICAL DIAGRAMS & SCHEMATICS	28 - 29
MDB Controller Connections	28
Dual Sensor Board	29
TROUBLESHOOTING.....	30 - 39
Coin Acceptance	30
Bill Acceptors	30
Control Board	30
All Coins Rejected	31
All Bills Rejected.....	32
Incorrect Change Dispensed	33
Selection Will Not Vend	34
Ice / Frost on Evaporator.....	35
Condensate on Outside of Product Door	35
Compressor Will Not Stop	35

Compressor Will Not Start	36
Machine Not Cooling.....	37
Selection Will Not Vend	38 - 39
ELECTRICAL DIAGRAMS & SCHEMATICS	40 – 54
DN55## Vender Non Energy Star 9 Column Wiring Diagram	40
DN55## Vender Energy Star 9 Column Wiring Diagram	41
DN35## Vender Non Energy Star 6 Column Wiring Diagram	42
DN35## Vender Energy Star 6 Column Wiring Diagram	43
Compressor Wiring Diagram.....	44
Domestic DN55## AC Distribution Box Non Energy Star Schematic.....	45
Export AC Distribution Box Schematic.....	46
Domestic DN35## AC Distribution Box Non Energy Star Schematic.....	47
Domestic DN55##/35## AC Distribution Box Energy Star Schematic	48
AC Distribution Box J2 Port Voltages	49
ECC Vender MDB 9 Column Wiring Diagram	50 - 51
Assembly, Domestic AC Distribution Box.....	52
Assembly, Domestic AC Distribution Box T8 Electronic	53
Assembly, Export AC Distribution Box CE/GS.....	54
PARTS LIST AND DIAGRAMS	55 – 89
Machine Front View 1	56 – 57
Machine Front View 2	58 – 59
Cabinet Detail.....	60 – 61
Lighting/Evaporator Fan	62 - 63
Service Door 1.....	64 – 65
Service Door 2.....	66 – 67
Service Door 3.....	68 – 69
Tall Tray Detail	70 – 71
Tall Gate Spacers	72
AC Distribution Box, Domestic.....	73 – 74
AC Distribution Box, Export	75 – 76
Refrigeration Unit DN59##/39## Fin & Tube Condenser.....	77 - 78
Refrigeration Unit DN59##/39## Fin & Tube Condenser.....	79 – 80
Electronics	81
Harnesses	82 – 83
Labels / Decals / Misc.	84
Screws & Nuts.....	85 – 86
Washers, Bolts, & Misc. Hardware	87 – 89

VENDER SAFETY PRECAUTIONS

Please read this manual in its entirety. This service information is intended for use by a qualified service technician who is familiar with proper and safe procedures to be followed when repairing, replacing or adjusting any Dixie-Narco vender components. All repairs should be performed by a qualified service technician who is equipped with the proper tools and replacement components, using genuine Dixie-Narco factory parts.



Warning

REPAIRS AND/OR SERVICING ATTEMPTED BY UNQUALIFIED PERSONS CAN RESULT IN HAZARDS DEVELOPING DUE TO IMPROPER ASSEMBLY OR ADJUSTMENTS WHILE PERFORMING SUCH REPAIRS. PERSONS NOT HAVING A PROPER BACKGROUND MAY SUBJECT THEMSELVES TO THE RISK OF INJURY OR ELECTRICAL SHOCK WHICH CAN BE SERIOUS OR EVEN FATAL.

IMPORTANT NOTE: This machine should not be used to vend perishable products without the Health Control Kit (622,010,20x.x4) installed. If you wish to vend perishable products, please contact Dixie-Narco for assistance.

PRODUCT IDENTIFICATION

The production date of Dixie-Narco products is determined by the date code incorporated in the serial number.

The vender serial number takes the form xxxx-yyzz. The first 4 digits (xxxx) identify the specific vender. The next 4 digits (yyzz) identify the manufacturing run that the vender was built in. The last two alpha characters (zz) identify the quarter and the year the vender was built. The first alpha character identifies the quarter as follows:

A = 1st Quarter
 B = 2nd Quarter
 C = 3rd Quarter
 D = 4th Quarter

The second alpha character identifies the year:

W = 1998 B = 2003
 X = 1999 C = 2004
 Y = 2000 D = 2005
 Z = 2001 E = 2006
 A = 2002 F = 2007

PHYSICAL CHARACTERISTICS

	DN 55##/54##
HEIGHT	72" (1828.8 mm)
WIDTH	43" (1092.2 mm)
DEPTH	32" (812.8 mm)
BASE	4.5" (114.3 mm)
SHIPPING WEIGHT	694 lbs. (314.8 kg)
Glass door is 33" (838.2 mm) wide, 56" (1422.4 mm) high	

	DN 2145
HEIGHT	72" (1828.8 mm)
WIDTH	42" (1066.8 mm)
DEPTH	32" (812.8 mm)
BASE	6" (152.4 mm)
SHIPPING WEIGHT	622 lbs. (282 kg)
Glass door is 30" (762 mm) wide, 52" (1320.8 mm) high	

	DN 35##
HEIGHT	72" (1828.8 mm)
WIDTH	32.5" (825.5 mm)
DEPTH	32" (812.8 mm)
BASE	4.5" (114.3 mm)
SHIPPING WEIGHT	545lbs. (246.9 kg)
Glass door is 23.08" (586.23 mm) wide, 56" (1422.4 mm) high	

RECEIVING INSPECTION

DO NOT STORE THE VENDER OUTSIDE.

Upon receipt, inspect the vender for any shipping damage. If there is any damage, have the delivery driver note the damage on the bill of lading and notify Dixie-Narco. Although the terms of sale are FOB shipping point, which requires the consignee to originate shipping damage claims, Dixie-Narco will gladly help if you must file a claim.

UNPACKING THE VENDER

Remove the stretch wrap, fiberboard edge protectors and corrugated front protector from the outside of vender.



Do not store the vender with stretch wrap on. Stretch wrap could bond to the vender's surface, which could damage the finish.

Remove the shipping boards from the bottom of the vender. The shipping boards are attached by the leveling legs. To avoid unnecessary damage to the leveling legs or base, remove the shipping boards by using a 1-1/2 inch socket type wrench to unscrew the leveling legs. Be sure to replace the legs after removing the shipping boards.

Once the vender is unpacked, check the recovery unit for any additional parts, price/ product labels, service/operation manual or other information concerning factory-equipped accessories such as coin mech and validator.



WARNING: TO AVOID THE POSSIBILITY OF A FIRE HAZARD, DO NOT STORE ANYTHING OR ALLOW DEBRIS OF ANY KIND TO ACCUMULATE IN THE BOTTOM OF THE SERVICE AREA, IN AND AROUND THE REFRIGERATION COMPARTMENT OF THE CABINET, OR IN FRONT OF THE EVAPORATOR AND CONDENSER COILS.



Warning

WARNING: ENSURE THAT POWER IS DISCONNECTED FROM THE VENDER OR THAT THE POWER INTERRUPT SWITCH IS NOT DEFEATED BEFORE INSPECTING OR REPLACING THE LAMPS, OTHER ELECTRICAL COMPONENTS, OR WORKING WITH OR ADJUSTING THE VENDING MECHANISM. FAILURE TO COMPLY WITH THESE INSTRUCTIONS MAY SUBJECT THE USER TO THE RISK OF ELECTRICAL SHOCK OR MECHANICAL INJURY, WHICH CAN BE SERIOUS OR FATAL.



ELECTRICAL POWER NEEDED

Refer to the cabinet serial number plate to determine the proper voltage and frequency the machine requires (domestically, this requirement is 120 Volts, 60 Hertz). The cabinet serial plate also indicates the amperage of the vender. The vender must be plugged into a properly rated, single phase alternating current outlet with its own circuit protection (fuse/circuit breaker).

DO NOT USE AN EXTENSION CORD.

GROUND THE VENDER

The vender is equipped with a three-wire power supply cord and **MUST** be plugged into a properly grounded outlet.



DO NOT REMOVE THE GROUND PIN OR IN ANY WAY BYPASS, MODIFY, DEFEAT, OR DESTROY THE GROUNDING SYSTEM OF THE VENDER.

If the outlet will not accept the power cord plug, contact an electrician to install a proper AC outlet.



Warning

FAILURE TO COMPLY WITH THESE INSTRUCTIONS MAY SUBJECT THE USER TO THE RISK OF INJURY OR ELECTRICAL SHOCK WHICH CAN BE SERIOUS OR FATAL. PERIODICALLY INSPECT THE POWER SUPPLY CORD FOR DAMAGE. IF THE CORD BECOMES DAMAGED IT MUST BE REPLACED WITH THE SAME SIZE AND TYPE CORD. CONTACT DIXIE-NARCO FOR ASSISTANCE.

INSTALLATION AND SETUP INSTRUCTIONS

Open the service door on the right side using the key provided in the coin return cup, or if shipped with a locking clip, remove the clip and install the lock. Ensure there is no power to the AC Distribution Box.

On venders with a main power switch on the AC Distribution Box the switch needs to be in the OFF position. On venders with a main power quick disconnect plug on the AC Distribution Box the quick disconnect plug needs to be unplugged. Check that all connectors are firmly seated on the control board and at the various components on the service door (coin mech, keypad, etc.).

Retrieve the main power plug from the hole in the rear of the vender and plug the cord in a properly grounded 120VAC, 15 Amp receptacle (U.S. and Canada).

Open the service door and apply power to the AC distribution Box (if equipped with a bill acceptor, the acceptor should cycle twice). The display on the door

should scroll the message "USE EXACT CHANGE", the fluorescent lamp should be lit and the cooling unit should start. If the display scrolls "OUT OF SERVICE", or the cooling unit fails to start, refer to the TROUBLESHOOTING FLOWCHARTS beginning on page 30.

SERVICE NOTE

Battery Backup

The battery backup is used to retain information programmed in the system (pricing, time, date, etc.) in case of power interruptions, or any time the main power is off. When the vender is shipped, the battery is connected and memory is being maintained. If the vender is to be stored for long periods of time, disconnecting the battery is recommended. The following steps will guide you through this procedure:

Open the service door and unplug the main power harness located on the front of the power box.

1. Locate the main control board mounted on the right side wall.
2. On controllers with a cover, remove the screw securing the cover to the board.
3. The backup system jumper is located just below the battery near the center of the board (refer to figure 1, page 25).
4. Remove the jumper covering the pins and place it on only one pin for storage.
5. Reinstall the cover, if used, and tighten the screw.
6. Reverse this procedure to connect the battery.

PLACING THE VENDER ON LOCATION

!! CAUTION !!



DO NOT TRANSPORT THE VENDER TO OR FROM THE LOCATION LOADED WITH PRODUCT OR DAMAGE TO THE VENDER MAY RESULT.

The vender is intended for **INDOOR USE ONLY**. It should be kept out of direct sunlight and away from any heat source.

The vender must be on a solid, flat and level surface. Ensure the flooring can bear the weight load of a fully loaded vender (approximately 1150 lbs.). The vender must be positioned close enough to an electrical outlet so that an extension cord is not required. If the machine will be subject to user misuse or vandalism, it is recommended that the vender be secured to the floor or wall as described in Dixie-Narco Technical

Bulletin 344. Due to the large size and weight of the Vender, never attempt to move the Vender with a Hand Truck or Stair Climber. Use a pallet jack or Vender/Cooler Dollies at all times when moving the Vender. The vender should never be slid or pushed in place. Never side load the leveling legs; doing so will cause damage to the legs. Do not transport the vender to or from customer locations loaded with product, as damage may result due to excessive weight. Call the Dixie-Narco Technical Service Department or your Dixie-Narco Representative for assistance.

LEVEL THE VENDER

Adjust the front leveling legs, ensuring that an even gap exists between the glass door and the top security angle and receiver box, and then level the cabinet front to rear. A carpenter's level will help verify that the vender is level. Leveling legs are adjusted using a wrench or socket 1 1/2" in size. If the vender is to be used in a bank of equipment, check the top and sides for proper alignment. If you are unable to properly level the vender, select an alternate location. **NEVER PLACE OBJECTS UNDER THE LEVELING LEGS OF THE VENDER**

DANGER

THE VENDER MUST BE PROPERLY LOCATED AND LEVELED. IF THE MACHINE WILL BE SUBJECT TO USER MISUSE OR VANDALISM IT IS RECOMMENDED THAT THE VENDER BE SECURED TO THE FLOOR OR WALL AS DESCRIBED IN DIXIE-NARCO TECHNICAL BULLETIN 344 TO MINIMIZE THE RISK OF INJURY OR DEATH FROM TIPPING. CALL THE DIXIE-NARCO TECHNICAL SERVICE DEPARTMENT OR YOUR DIXIE-NARCO REPRESENTATIVE FOR ASSISTANCE.



SPACE THE VENDER

Do not block the rear of the vender. Maintain a minimum of 4 inches (10 cm) from the wall to ensure adequate airflow to the condenser and compressor. At the front of the vender, make sure that nothing obstructs the air intake at the bottom of the service door and cabinet. At the rear of the vender, make sure nothing obstructs the air exhaust at the bottom of the cabinet.

WARNING



TO AVOID THE POSSIBILITY OF A FIRE HAZARD, DO NOT STORE ANYTHING OR ALLOW DEBRIS OF ANY KIND TO ACCUMULATE IN THE BOTTOM OF THE DOOR, IN THE BOTTOM OF THE SERVICE AREA, IN AND AROUND THE REFRIGERATION COMPARTMENT OF THE CABINET, OR IN FRONT OF THE EVAPORATOR AND CONDENSER COILS.

INSTALLING PRICE LABELS

Pricing labels included in the literature package kit. They are double sided and range in price from .25 to 9.95. The price labels are inserted at the top of the front knuckle of each release mechanism.

Remove the pricing label sheets from the service manual package and gently remove the label corresponding to the vend price of each selection by tearing at the perforation. The label is inserted between the grooves at the top of the front knuckle by slightly bending sides of the label toward the front of the vender being careful not to crease the label. Once inserted, push the label firmly against the front of the knuckle. This will insure the label is locked in place and will not fall out during normal operation of the vend mechanism.

INSTALLING FLAVOR CARDS

For problem free vending, it is necessary to load the venders columns consistently with same product every time the vender is filled. To ensure consistent loading, flavor cards are included for the slide assemblies with every vender and should be installed into the product pusher to designate to the route driver which product the column is set for.

To install the flavor card, simply detach it from the sheet at the perforation and slide it into the slots in the product pusher.

COIN CHANGERS & OTHER ACCESSORIES

The vender must have an MDB coin changer installed and can have an MDB bill acceptor installed as well. If the MDB coin changer and other MDB accessories are not factory installed, refer to the instructions received from the manufacturer of the MDB coin changer and other MDB accessories for proper set-up and installation.

The vender will support the following Domestic MDB coin changers:

Coinco 9302GX, USG-701 Quantum
Mars TRC-6510, TRC-6512, TRC-4010
Conlux CCM-5G 1-2-3-4-5

The vender will support the following domestic MDB Bill validators:

Coinco BA-30 B, BA-50B Coinco Mag 50
Mars VN 2512 Conlux NBM-3000 Series

The vender will support the following MDB card readers:

Debittek VMC LTD
Danyl Schlumberger Fage
Diebold Systems Jofemar
AT&T Campus Wide Evend.net
Danyl Smartcard

The above listed peripherals indicate units that have been tested by Dixie-Narco at the time of printing of this manual and are not all-inclusive. For information regarding other types not listed here, please contact Dixie-Narco Technical Service Department.

SETTING THE TEMPERATURE CONTROL

This vender is equipped with a manual thermostat. It is located on the power distribution box inside the service area. This thermostat is factory pre-set to maintain a cabinet temperature of 33 to 38 degrees Fahrenheit (1 to 3 degrees centigrade), however, occasional adjustment may become necessary. It is also a good practice to ensure the proper operating temperature prior to installing the vender on location.

To set the temperature, apply power to the vender and allow it to run for several hours with the glass door closed or until the minimum cabinet temperature is achieved. Then, using one of the methods below, verify the temperature inside the cabinet:

1. If your vender is equipped with an electronic temperature sensor, use the keypad on the service door to show cabinet temperature in Fahrenheit by pressing the F key followed by the asterisk (*) key or in Centigrade by pressing the C key followed by the asterisk key. The temperature will be shown on the digital display located on the front of the service door.
2. If your vender is not equipped with a temperature sensor, place a thermometer in the center of the C shelf when vender is first powered up. Make sure the thermometer is placed in a location that permits reading the temperature with the glass door closed. This will prevent the introduction of warm, ambient air.

Adjustments are made by turning the screw in the center of the control (Shown in fig. 1) clockwise for colder product or counterclockwise for warmer product. It is recommended that the control screw be adjusted in very small increments allowing the refrigeration unit to cycle off and then verifying the

temperature again using one of the methods listed above prior to further adjustment.



Fig 1
Temperature Control
Adjustment. (Arrow
shows location of
adjustment screw)

LOADING THE VENDER

All venders are shipped with an assortment of spacers. Please contact a Service Representative or refer to the proper Technical Publication for spacer settings.

Load product in each column one package at a time insuring that the package being loaded is in front of the product pusher. If the package is narrower than the column, use the correct spacer to insure a snug (not tight) fit against the left side of the column. Test the column spacing by pulling firmly on the front package. If the package pulls out of the column easily, recheck the spacer being used. Also insure that the package is stable within the column (doesn't move excessively from side to side). Some packages are wider at the base than in the center. These packages will have the tendency to lean forward on the front of the gate assembly and create a jam if not properly set up. A properly loaded column will allow the product to slide freely into the gate area but not allow the product to squeeze past the front knuckle of the release mechanism. After loading the vender, test vend each column to insure proper operation.

LOADING CHANGE TUBES

The changer tubes can be loaded using one of the following methods:

1. Load the coin mechanism with coins to the desired level by inserting coins in the loading slots on the coin tube front.

Minimum coin tube levels are:

6-8 nickels

7-8 dimes

5-6 quarters

Note: A low coin level in the coin tubes will interfere with operation of the bill validator.

2. For exact cash accountability and to insure maximum dollar bill acceptance, load the mechanism utilizing the coin insert slot on the front of the vender while in the coin tube fill/dispense mode in the test menu. (see page 17 in the programming section for more information)

(For additional information about coin mechanism, refer to the manufacturer's instructions.)

POWER DISTRIBUTION BOX

The power distribution box is where the 120VAC input voltage is broken down to the main operating voltages of the vender (24 VAC and 12 VAC) by a transformer. Those voltages are sent to the controller via the J1 (12 pin) connector. It also contains 3 fuses that protect the VMC, transformer, and solenoids. The power distribution box also distributes AC power to the lights, evaporator fan, and refrigeration system, which are always energized when the vender is powered up. It is located inside the service area, mounted to the back wall.

VENDING MACHINE CONTROLLER (VMC)

The vending machine controller is the heart of the Glass Front Vender and is located on the right side wall inside the service area. It contains the program chip (EPROM), which controls all aspects of the vender with the exception of the refrigeration unit and lighting. It also contains the power supply which regulates the voltages required to operate the vend solenoids as well as the changer, coin mechanism, digital display and all logic functions in the vender.

Keypad

The keypad is located on the front of the service door. It consists of a 6 inch X 3 inch matrix, membrane switch pad and a rubberized actuator pad. The pad utilizes the letters A thru F on the left side and numbers 1 thru 0 along with the * symbol and Clr to the right. The keypad is where the vender programming is accomplished and where the customers make their selections.

DIGITAL DISPLAY

The digital display is located directly above the keypad on the front of the service door. It is an 8 digit 14-segment alphanumeric display. It is used to convey information to the consumer as well as to the person programming the vender. The backside of the digital display, inside the service door, contains the service mode switch. It is a blue button that is depressed a number of times in order to access different programming menus.

REFRIGERATION SYSTEM

The refrigeration system is a single piece unit and is hermetically sealed. In the DN55###/DN35###/DN2145 models consist of a ½ horsepower compressor, with a single fin and tube style condensing unit with one fan, the condensation overflow pan and the evaporator. The evaporator is located behind the panel on the right side of the cooling compartment directly adjacent to the bottom shelf. The remainder of the unit is located behind the delivery bin, mounted to the bottom

of the cabinet. This unit is designed for easy removal and replacement from the front of the vender as a complete assembly. An electronic thermostat regulates the cabinet temperature. The bulb of the thermostat is attached to the evaporator coils and reads the temperature of the refrigerant inside the coil.

SHELF ASSEMBLY

Typically, there are 5 shelf assemblies in every vender; however, this can vary depending upon the configuration specified at the time of ordering. Each can/bottle shelf consists of 6, 8, or 9 columns. Each shelf is capable of holding a variety of products. The shelf assembly consists of the tray, where all of the following parts are mounted: Gate assembly, shelf stabilizers and the slide/pusher assembly. Each snack/food shelf consists of 5, or 11 columns. Each shelf is capable of holding a variety of products. These items are discussed in detail below.

SHELF STABILIZERS

Some packages will have the tendency to become unstable or bounce to the delivery bin when vended due to the design of the bottom of the package. This can lead to a product jam. The shelf stabilizer (the clear Lexan tab at the front of the tray) is used to prevent this from occurring by acting as an extension of the shelf.

Unless otherwise specified at the time of ordering, shelf stabilizers are installed on the C and D shelves of the vender. The stabilizers that are installed on the C shelf can also be used on the A and B shelves as needed for product stability. The stabilizers installed on the D shelf must be used only on that shelf as they are longer and may interfere with the proper vending of a column. Do not use shelf stabilizers on the bottom tray as product jams may occur.

To install the stabilizers, the slide assembly must first be removed from the column. The stabilizer is inserted on the bottom of the slide assembly by firmly pushing the square hole in the stabilizer onto the front locking tabs of the slide. The slide is then installed back into the column.

GATE ASSEMBLY (Can/Bottle Trays)

The gate assembly is mounted on the front portion of the tray assembly and contains the vending mechanism. Incorporated in the gate assembly are the front and rear knuckle assemblies as well as the product kicker.

In standby operation, the front knuckle is in the blocking position, which holds the front (displayed product) in position to be vended. The rear knuckle assembly is in a flat position, which allows product to enter the gate area, and the kicker is flush to the rear knuckle assembly. A stainless steel pin is inserted through the rear most portion of the front knuckle assembly and connects to a solenoid plunger below the tray. When a selection is made, the solenoid energizes pulling the plunger toward the back of the

tray. At the same time the front knuckle is opened into a flat position, the rear knuckle is closed to a blocking position, holding the remaining product out of the gate area, and the kicker is extended to firmly push the front (displayed product) off of the tray. The solenoid is energized for approximately 1-½ seconds to allow ample time for the displayed product to be ejected from the shelf. The solenoid is then released and the front knuckle returns to the blocking position, the rear knuckle and kicker return to their standby position and the next product slides into the vend (display) position.

SLIDE/PUSHER ASSEMBLY

The slide/pusher is located on the bottom of each product column. Its purpose is to provide a slick, friction resistant surface for the product to rest on. The product pusher is mounted on the top of the slide and incorporates a coil spring in the body that attaches to the bottom of the slide through a slit. This spring adds needed tension to insure that all products in the column remain tight against each other and are allowed to progress into the gate area.

Although these pushers reduce the effects of dirt and grime, periodic cleaning and lubrication of the slides is recommended. **DO NOT USE SOLVENTS OR ABRASIVE MATERIALS TO CLEAN ANY PORTION OF THE TRAY.**

GENERAL INFORMATION

In order to fully utilize the many features of your vender it is important that you first understand the options available and procedures for programming the vending controller unit (control board).

All programming, testing, and service functions are accomplished by using the keypad in an easy to follow, display prompted format. There are four modes of operation for servicing, testing, and setting up your vender. The modes of operation are accessed by, opening the service door, and pressing the service button (blue button on back of display module or the service button on the control board).

The service button will cycle through each of the four modes in turn: Service Mode, Test Mode, Set-Up Mode and Setup Mode 2. In each of these modes, the "A" key is used to scroll through the available options/settings within that mode/selection. (Note: In each of the mode selections, pressing the character key next to the listed option will take you directly to that feature - see menu items chart on page 12.), the "*" key is used as an enter key to select the currently displayed item/feature, and the "CLR" key is used as a done or exit key. Closing the service door or pushing the service door switch will exit the function you are currently in and place the vender back in service.

EXTERNAL DISPLAY ITEMS (HOT KEYS)

Allows the service technician to view several items via the display without opening the vender. There are four options that can be viewed externally:

1. **Display temperature in degrees "C"**. To view, press the "C" then press the * key. The display will then show the vender's inside temperature in degrees "C". Note: The temperature will only display if temperature sensor hardware kit is installed.
2. **Display date/time**. To view, press the "D" key, then press the "*" key. The display will then show the current date and time.
3. **Display power condition** as a number value. Typical value ranges between 30V and 34V. To view, press the "E" key, then press the "*" key. The display will show the vender's current power condition.
4. **Display temperature in degrees "F"**. To view, press the "F" key, then press the "*" key. The display will show the vender's inside temperature in degrees "F". Note: This will only display if temperature sensor hardware kit is installed.
5. **Selection status messages** When selecting an item that can not be vended the display will show one of the following:
 - a. **"Not Available Until HHMM"** – The selection is blocked under the Not Available setting and will become available at the indicated time.

- b. **"Select Another Item <code>"** – The selection can not vend due to the error code indicated. The code can be one or more of the following:
 - i. **"N"** – Controller has determined the solenoid is missing.
 - ii. **"V"** – Controller detected a solenoid fault on this selection.
 - iii. **"H"** – Selection has been blocked under Health Guard.
 - iv. **"D"** – Selection has been blocked by Enabled Item mode.
 - v. **"Sold Out"** – Product was not detected after previous vend and controller has marked selection as sold out.
 - vi. **"Cool In ### Minutes"** – Selection has been placed under cool down control and will be available at the indicated time.

6. **DEX status messages**. The controller will display the result of a DEX transfer for 2 seconds upon completion.
 - a. **"DEX OK"** – No communication errors occurred, the DEX transfer was completed successfully. Some handheld devices may perform their own processing of DEX data after a transfer. The success of such operations is independent of this status indication.
 - b. **"DEX ERR"** – A communication error occurred. This can include a handshake error, an incorrect response, or no response from the audit device.
 - c. **"DEX PW"** – A DEX operation was attempted with out a valid DEX password. The operation did complete successfully.
7. **Error Alert**. When the service door is opened, the controller will beep 3 times and display "CHK ERRS" to alert service personnel to the presence of error conditions. The service personnel should proceed to the List Errors function in Test Mode to determine the failure.

NORMAL OPERATION MESSAGES

At initial power-up, the program will start and the display will briefly show the software version in use as VER###.## (i.e. 030.41), followed by the default idle message, "ENJOY A REFRESHING DRINK NOW", or the user entered point of sale message unless these are overridden by a higher priority status message.

INITIAL PROGRAMMING

DATE/TIME

Proper setting of items such as Happy Hour and Not Available Times, as well as obtaining information regarding Door Openings, Power Outages, etc. depend on a correct DATE/TIME setting. This setting, while set at the factory, should be checked and changed if necessary. Enter "SETUP MODE" by opening the service door and pressing the Service Button 3 times. Press the number 5 key; the day, date, and time will scroll across the display in the following format: SUN 09/08/02 1330. To change press the "*" key and the display will read "SAT". Use the "A" key to scroll through the days. When the desired day is displayed, press the "*" key. The display will read "MONTH". Enter the 2 digits for the month and press the "*" key. The display will read "DAY". Enter the date (2 digits) and press the "*" key. The display will read "YEAR". Enter the year (last 2 digits) and press the "*" key. The display will read "HOUR". Enter the hour (00 – 23) and press the "*" key. The display will read "MIN". Enter the minutes (00 – 59) and press the "*" key. The date/time is now set and the display will return to "SETUP MODE".

REGULAR PRICES

Allows the setting of regular prices for an individual item, a complete tray, or the entire machine. Factory setting is \$99.95.

Press the number "7" on the keypad and the display will scroll "SET REGULAR PRICES". Press the "*" key and "\$00.00" will be displayed. Prices are entered using the numbers on the keypad and will shift in from the right as numbers are pressed. Once the desired price is showing on the display, use one or all of the options listed below for setting the price to the desired selection:

1. **All selections.** Press the * key after entering desired price and all selections in the vender will now be set
2. **One tray.** Pressing the letter of the shelf followed by the * key will price that shelf to a single price. For example, to price the A shelf for \$1.25, first dial in the price then choose A followed by *.
3. **Single selection.** Press the desired selection number or numbers corresponding to the selections that require changing.

Priority will be given to the higher ranked method. For example, If one price on the A tray was set to \$1.50 using option 3 above and you wish to change the remaining selections on that tray using option 2, the pricing for the entire tray would take precedence. Conversely, if the price was set using option 2 first followed by the single selection using option 3, the pricing for the remainder of the shelf would remain

and the new price for the single selection would change to the new value.

Press the "CLR" key to return to "SERVICE MODE".

POINTS TO REMEMBER:

- Prices entered must not exceed the "MAX CREDIT" set in the system's program.
- DO NOT press the "*" key when setting prices for individual selections.

HAPPY HOUR TIMES (not available 030.81 & higher) Password protected. Before entering or changing this setting you must enter the password. To set Happy Hour Times enter the "SETUP MODE" by opening the service door and pressing the Service Button 3 times. Press the number 2 key; the display will scroll "SET HAPPY HOUR". Press the "*" key and the display will show "PW". Enter the password and the display will flash "OK". Then "HH START TIME 00 00" will scroll across display.

POINTS TO REMEMBER:

- Before setting Happy Hour times and days, it is recommended you check the DATE/TIME settings.
- All times entered must be in 24 hour format.

HAPPY HOUR PRICES (not available 030.81 & higher)

To set Happy Hour Prices enter the "SERVICE MODE" by opening the service door and pressing the Service Button once. Press the number 8 key; the display will scroll "SET HAPPY HOUR PRICES". Then "\$0.00" will be displayed. As the prices are entered the numbers will shift in from the right on the display. When the desired price is displayed it may be assigned to an individual selection, an entire tray (shelf), or to all selections in the machine. When setting prices for individual selections DO NOT press the "*" key. The "*" key is only used to assign a price to an entire tray or to all selections in the machine. When setting one price for an entire tray the "*" key is pressed after designating the tray (display reads \$1.00 A), when the "*" key is pressed the display will read "\$1.00 A" momentarily, then will return to just the price. When setting one price for an entire machine the "*" key is pressed after entering the price (display reads \$1.00), when the "*" key is pressed the display will read "\$1.00 *" momentarily, then will return to just the price. When setting prices for individual selections the tray and column (A1) is entered following the price. As soon as the column number is pressed, the price and selection will be displayed momentarily ("1.00"), then the display will return to just the price. Always check the setting for "MAX CREDIT" before setting prices (not applicable to International machines).

POINTS TO REMEMBER:

- Prices entered must not exceed the "MAX CREDIT" set in the system's program.

- DO NOT press the “*” key when setting prices for individual selections.

SET NOT AVAILABLE TIMES

Password protected. Before entering or changing this setting you must enter the password if one has been assigned. This mode allows up to 4 different time periods that use of the machine may be restricted. To set Not Available Times enter the “SETUP MODE” by opening the service door and pressing the Service Button 3 times. Press the number 3 key; the display will scroll “SET NOT AVAILABLE TIME”. Press the “*” key and the display will show “SHUTDOWN”. Press the “A” key and the display will show “BLOCK 1” which allows selection set up. Press the “A” Key to scroll through the 4 different time periods (Block 1, 2, 3, 4) that operation of the machine will be restricted. Press the “*” key and the controller will begin displaying selections currently belonging to block until all have been displayed or the “*” key is pressed and display will show “END LIST” then “ITEM”. There are now three (3) choices:

- 1) ALL SELECTIONS. Press the “*” key and all selections in the vender will be set for not available.
- 2) ONE TRAY. Pressing the letter of the shelf (tray) followed by the “*” key will set control for all selections on that shelf.
- 3) SINGLE SELECTION. Press the desired selection number or numbers corresponding to the selections that require the set not available times.

Press the key buttons again and the display will flash “DISABLED” and return to “ITEM”. Priority will be given to the higher ranked method. If one selection on the A tray was set to “ENABLE” using option 3 above and you wish to change the remaining selections on that tray using option 2, the Setting for the entire tray would take precedence. Conversely, if the tray was set using option 2 first followed by the single selection using option 3, the setting for the remainder of the shelf would remain and the new set not available setting would take affect. If “DISABLED” the selection will be blocked during the scheduled time period. Press the “CLR” key will exit the selection setup & start the schedule setup. “START TIME” will scroll on display once and change to “HOUR 00”. Enter the hour (00 – 23) and press the “*” key. The display will read “MIN 00”. Enter the minutes (00 – 59) and press the “*” key. “END TIME” will scroll on display once and change to “HOUR 00”. Enter the hour (00 – 23) and press the “*” key. The display will read “MIN 00”. Enter the minutes (00 – 59) and press the “*” key. “SUN N” (day) will show on the display. Press the “A” Key to toggle to “SUN Y”. To change to the next day press the “*” key and the display will read “MON N”. Use the “A” key to scroll through the days. When the desired day is displayed, press the “*” key to scroll to the next day. Press the “CLR” key to move to “BLOCK 2”.

POINTS TO REMEMBER:

- Before setting Not Available times and days, it is recommended you check the DATE/TIME settings.
- All times entered must be in 24 hour format.

SERVICE MODE MENU ITEMS

SERVICE MODE

- A Next Item
- B Cash Box
- C Sales
- D Display Temperature
- E Set Cool Down
- F Clear Totals
- 1 Number Sold
- 2 Enable Item
- 3 Sales by Column
- 4 Escrow
- 5 Force Vend
- 6 Audio Feedback
- 7 Set Regular Prices
- 8 Happy Hour Prices (not available in 030.81 & up)
- 9 Relay Toggle Test
- 0 Clear Errors

SETUP MODE

- A Next Item
- B Enter Message
- C Clear Message
- D *Enable/Disable \$*
- E Clear Cool Down
- F *Master Reset*
- 1 Machine Number
- 2 Set Happy Hour (not available in 030.81 & up)
- 3 *Set Not Avail. Time*
- 4 *Winner Mode* (not available in 030.81 & up)
- 5 Date/Time
- 6 Total Sales
- 7 *Health Guard Enabled/Disabled*
- 8 *Drop Sensor Enabled/Disabled*
- 9 Set Cool Time
- 0 *Enter New Password*

TEST MODE

- A Next Item
- B List Errors
- C Self Test
- D Display Test
- E Keypad Test
- F Auto Sequence
- 1 Tube Fill/Dispense
- 2 Daylight Savings Time
- 3 Set Not Available Mode
- 4 Set Credit Timer Mode
- 5 Door Open
- 6 Power Out
- 7 Test Health Guard
- 8 Display Health Guard
- 9 Test Vend
- 0 Clear Errors

SETUP MODE 2

- A Next Item
- B STS Enabled/Disabled
- C Custom STS Configuration
- D Default STS Configuration
- E Display STS Configuration
- F Set Vend Limit (not available in 030.81 & up)
- 1 Health Recheck Enabled/Disabled
- 2 Set Retry Limit
- 3 Sold Out Enable Enabled/Disabled
- 4 Price Display Enable Enabled/Disabled
- 5 Sensor Override Enabled/Disabled
- 6 Interval Clearing Is On/Is Off
- 7 Set Lights Off
- 8 Set Refrigeration Temp
- 9 Set Storage Time
- 0 Set Storage Temp

Note: all items in *Italics* under SETUP MODES require password entry for access if one has been assigned.

FACTORY DEFAULT REQUIRES NO PASSWORD UNTIL NEW PASSWORD OTHER THAN 0000 IS ENTERED.

Menu items shown above reflect software revision 804,917,030.81 and higher.

Service Mode	Pages 14 through 16
Test Mode	Pages 16 through 19
Setup Mode	Pages 19 through 21
Setup Mode 2	Pages 21 through 23

SERVICE MODE MENU ITEMS

SERVICE MODE

Enter SERVICE MODE by opening the service door and pressing the Service button once. The display will read "SERVICE MODE". The following choices are now available:

NEXT ITEM - Press key "A"

CASH BOX - Press key "B"

Shows the amount inserted into the bill validator and the change diverted to the cash box from the coin mechanism since the last CLEAR TOTALS or MASTER RESET. To view the cash box totals, press the letter "B" on the keypad and the display will scroll "CASH BOX", then display #.##.

Press the "CLR" key to return to "SERVICE MODE" or press the "A" key to advance to the next menu item below.

SALES - Press key "C"

Shows total sales since last CLEAR TOTALS or MASTER RESET. This total includes change not diverted to the cash box and still being held in coin mechanism escrow tubes. To view the total sales press the letter "C" on the keypad and the display will scroll "SALES", then display #.##.

Press the "CLR" key to return to "SERVICE MODE" or press the "A" key to advance to the next menu item below.

DISPLAY TEMP (if temperature sensor hardware kit is installed) - Press key "D"

Shows the cabinet temperature in degrees Celsius or degrees Fahrenheit. Press the letter "D" on the keypad. The display will scroll "Display Temperature". Pressing the letter "C" on the keypad will display the temperature in degrees Celsius. Pressing the letter "F" on the keypad will display temperatures in degrees Fahrenheit. If no sensor is installed, "TEMP SEN" will appear on the display. NOTE: THIS SETTING DOES NOT CHANGE THE APPEARANCE OF THE DIGITAL DISPLAY IN THE STANDBY OR OPERATION MODE.

Press the "CLR" key to return to "SERVICE MODE" or press the "A" key to advance to the next menu item below.

SET COOL DOWN - Press Key "E"

Allows the service technician to set the cool down period for each selection that is warm after restocking. This feature may be set on an individual item, a complete tray, or the entire machine. Once set, the cool down period duration is the time entered by the service technician in SET COOL TIME, or the default time of 240 minutes if no time

was entered. Press the letter "E" on the keypad and display will scroll "SET COOL DOWN". Press the "*" key on the keypad and the display will read "ITEM". There are now three choices:

1. Pressing the "*" key will place the entire machine in cool down.
2. Pressing a tray selection followed by "*" will place that tray in cool down. For example, pressing "A*" will place the "A" tray in cool down.
3. Pressing an item selection will place just that item in cool down. For example, pressing "A1" will place that selection only in cool down.

After making any of the above selections, an audible tone will be heard and the display will change momentarily to "OK" then back to the price.

The larger of the settings will carry a priority in the programming sequence. For example, if you first programmed "A1" for cool down then pressed "A*", the "A*" setting would take precedence. Conversely, if "A*" was programmed first followed by "A1", the "A*" setting would still take precedence but the "A1" selection will be disabled from the cool down cycle.

After the COOLDOWN is set and the vender is returned to the operating mode, the display will prompt the consumer via the digital display as to how many minutes remain in the cool down cycle (for example, the A tray was programmed for cool down and the customer tried to purchase item A6. The display would read "product cool in ### minutes" where ### represents the time remaining for the cool down cycle.

Press the "CLR" key to return to "SERVICE MODE".

CLEAR TOTALS - Press key "F"

Allows the service technician to clear totals in CASH BOX, SALES, NUMBER SOLD, DOOR OPENINGS, POWER OUTAGES, and SALES BY COLUMN. Press the letter "F" on the keypad and the display will scroll "CLEAR TOTALS". Press the "*" key, the display will read OK momentarily and an audible tone will be heard. The totals are cleared and the display returns to "SERVICE MODE".

NUMBER SOLD - Press key "1"

Shows the total number of items sold since the last CLEAR TOTALS OR MASTER RESET. Press the number "1" on the keypad and the display will scroll "NUMBER SOLD", then change to ##.

Press the "CLR" key to return to "SERVICE MODE" or press the "A" key to advance to the next menu item below.

ENABLE ITEM - Press key "2"

Allows an individual selection, a complete tray, or the entire machine to be enabled or disabled. This is

most commonly used when a selection is out of order and you are awaiting parts and do not want the customer to utilize that selection. Press the number "2" on the keypad and the display will scroll "ENABLE ITEM". Press the "*" key and the display will read "ITEM". There are now three choices:

1. Pressing the "*" key will toggle between enabled and disabled for the entire machine, the display will show the new state i.e. enabled or disabled.
2. Pressing a tray selection followed by "*" will show the new state of that tray. (For example, pressing "A*" will show the new state for the A tray. Pressing "A*" again will toggle the state.)
3. Pressing an item selection will show the current state of that item; for example, pressing "A1" will show the new state of that item, pressing "A1" again will toggle the state.

After making any of the above selections, an audible tone will be heard and the display will read OK momentarily.

If a selection has been disabled in this mode and the customer tries to purchase from the programmed selection(s), the vender will display "SELECT ANOTHER ITEM".

Press the "CLR" key to return to "SERVICE MODE".

SALES BY COLUMN - Press key "3"

Shows the total number sold from each selection since the last CLEAR TOTALS or MASTER RESET. Press the number "3" on the keypad and the display will scroll "SALES BY COLUMN". Press the "*" key and the display will read "ITEM". Select the item to be checked (the total number sold from that selection will be on the right side of the display and the item number will be on the left side of the display). Press the "CLR" key to return to service mode.

ESCROW - Press key "4"

Allows a bill to be returned if the change return lever is pressed before a selection is made. Factory setting is ESCROW N.

Press the number "4" on the keypad and the display will read "ESCROW Y" or "ESCROW N", depending on the current state. Pressing the "*" key toggle the vender from ESCROW Y to ESCROW N. Example: If "ESCROW Y" is showing on the display, pressing the "*" key will disable the escrow function and the display will read ESCROW N.

This feature only affects those machines with a bill validator installed. Press the "CLR" key to return to "SERVICE MODE".

FORCE VEND - Press key "5"

Forces the customer to make a vend by inhibiting the coin return lever once the minimum vend price line has been met or exceeded The coin return lever

will not be inhibited if there is not enough credit to vend the lowest priced item or if a vend failure has occurred. Factory setting is "FORCE N".

Press the number "5" on the keypad the display will read "FORCE Y" or "FORCE N", depending on the current state. Pressing the "*" key will toggle the state. Press the "CLR" key to return to "SERVICE MODE".

AUDIO FEEDBACK ENABLED/DISABLED - Press key "6"

Allows an audible tone to be turned on and off. If enabled, an audible tone is heard when keys are pressed when making a selection and when programming the vender.

Press the number "6" on the keypad and the display will scroll "ENABLE AUDIO FEEDBACK" or "DISABLE AUDIO FEEDBACK". The factory setting is disabled. Press the "*" key with the setting you wish to use showing on the display. An audible tone will be heard and the display will change to "OK", then return to Service mode.

SET REGULAR PRICES - Press key "7"

Allows the setting of regular prices for an individual item, a complete tray, or the entire machine. Factory setting is \$99.95.

Press the number "7" on the keypad and the display will scroll "SET REGULAR PRICES". Press the "*" key and "\$00.00" will be displayed. Prices are entered using the numbers on the keypad and will shift in from the right as numbers are pressed. Once the desired price is showing on the display, use one or all of the options listed below for setting the price to the desired selection:

4. **All selections.** Press the * key after entering desired price and all selections in the vender will now be set
5. **One tray.** Pressing the letter of the shelf followed by the * key will price that shelf to a single price. For example, to price the A shelf for \$1.25, first dial in the price then choose A followed by *.
6. **Single selection.** Press the desired selection number or numbers corresponding to the selections that require changing.

Priority will be given to the higher ranked method. For example, If one price on the A tray was set to \$1.50 using option 3 above and you wish to change the remaining selections on that tray using option 2, the pricing for the entire tray would take precedence. Conversely, if the price was set using option 2 first followed by the single selection using option 3, the pricing for the remainder of the shelf would remain and the new price for the single selection would change to the new value.

Press the "CLR" key to return to "SERVICE MODE".

HAPPY HOUR PRICES - Key "8

Not available in software revisions 030.81 and higher.

Allows the setting of Happy Hour prices for an individual item, a complete tray, or the entire machine. Press the number "8" on the keypad and the display will scroll "SET HAPPY HOUR PRICES". Press the "*" key and "\$00.00" will be displayed. Happy Hour prices are entered in the same way as regular prices. Refer to price setting above.

Press the "CLR" key to return to "SERVICE MODE".

RELAY TOGGLE TEST - Press key "9"

If Vender is manufactured Energy Star compliant or has Health Guard Kit installed.

Allows the service technician to test the relay electronic control of the Compressor (C), Evaporator Fan (F), and Lights (L). Press the number "9" key on the keypad and the display will scroll "RLY TOGL" briefly and then "CO FO LO" will appear. Press the letter "C" to enter the Compressor Relay test. Pressing number "1" on the key pad will toggle the relay on (C1) or off (C0). CAUTION: Disconnect the power supply to the compressor before testing the compressor relay. Failure to disconnect the relay may result in damaging the compressor. . Press the letter "F" to enter the Evaporator Fan Relay test. Pressing number "1" on the key pad will toggle the relay on (F1) or off (F0). . Press the letter "L" to enter the Light Relay test. Pressing number "1" on the key pad will toggle the relay on (L1) or off (L0). Press "CLR" to return to "Service Mode".

CLEAR ERRORS - Press key "0"

Allows the service technician to clear any recorded errors. Press the number "0" on the keypad and the display will scroll "CLEAR ERRORS". Press the "*" key and the display will read "OK" momentarily and an audible tone will be heard. The errors are cleared and the display returns to "SERVICE MODE".

TEST MODE

Enter TEST MODE by opening the service door and pressing the blue Service button twice. The display will read "TEST MODE".

NEXT ITEM - Press key "A"

LIST ERRORS - Press key "B"

Allows the service technician to view a list of all recorded errors. Press the letter "B" on the keypad and the display will scroll "LIST ERRORS", then change to "NO ERROR" if no errors exist or, if errors are present, one of the error prompts below will be displayed. If an error code is displayed, press the "*" key

to view the next error until "END LIST" is displayed. With "END LIST" showing on the display, press the "CLR" key to clear errors. When the "CLR" key is pressed, an audible tone will be heard and the display will change momentarily to "OK" then back to TEST MODE. If you wish to exit the list without clearing errors, simply push the "*" key and the display will return to list errors. If the CLR key is pressed prior to reaching the end of the list, the display will jump to END LIST.

Explanations for the error codes are listed below. Note: The prompts listed will only show on the display if an error has occurred.

NO ERROR No errors have occurred.

COIN ERR Indicates a fault message from the coin mechanism.

BILL ERR Indicates a fault message from the bill validator.

CARD ERR Indicates a fault message from the card reader.

MDB ERR Indicates a communication error between the control board and peripherals.

MEM ERR Indicates a problem with the program memory or associated components. This is a fatal error and will shutdown the machine. This error will usually occur if the battery on the controller is in need of replacement or if a "MASTER RESET" occurred due to changing the controller EPROM or by manually doing a MASTER RESET. After clearing this error, the vender will have to be reprogrammed, as all options will have been reset.

VEND ERR Indicates one or more channels/solenoids are out of service. When the display reads "VEND ERR", press the "A" key and the first channel/solenoid with a problem will be displayed. Continue pressing the "A" key to display additional vend errors (if any) until the display returns to "VEND ERR". NOTE: IF THIS ERROR IS SHOWN, ALL PROBLEMS MUST BE REPAIRED AND A "SELF TEST" (see below) MUST BE PERFORMED IN ORDER TO RETURN THE LISTED CHANNEL/SOLENOID TO SERVICE.

PWR OUT Indicates an interruption of the power to the controller board. When the display reads PWR OUT, press the "A" key and the date and time of the last power interruption will be displayed. Continue pressing the "A" key and the display will show the time and date of the last 5 power outages, starting with the most recent.

LOW 28V Indicates a problem with the controller board's 28 Volt power supply. This is a fatal error and will put the vender out of service until resolved.

ROW a ERR The a represents the letter of the row drive that failed (A-F ie. ROWBERR) and gives the indication that the B row failed during the last test firing. This error will only occur while performing the "SELF TEST" (see explanation below) and the controller board has encountered a short or a very high current condition.

COLnERR The *n* indicates the number of a column driver (1-9, i.e. COL1ERR). This error is displayed if the controller has detected a short or a very high current condition during the last test firing.

This is a fatal error and will put the vender out of service until resolved.

OVER CUR Indicates an over current condition has occurred (i.e. a shorted component or a low power condition). This error is serious. If it reoccurs after CLEAR ERRORS, further troubleshooting will be required.

TEMP SEN Indicates a temperature sensor failure while health control is enabled.

HEALTH T Indicates the temperature in the vender did not reach 41 degrees F within 30 minutes after the door was closed.

***HEALTH"C** Indicates the temperature in the vender went above 41 degrees F since the last door closure or remained above 41 degrees F for longer than 15 minutes.

NO KEYPAD Indicates a failure of the keypad or associated cable (will show on display on power up and stay there until problem is resolved).

BAD RAM Indicates a problem with the control board.

END LIST Indicates you have scrolled through the list of all present errors. Press the "CLR" key and display will change to "OK", an audible tone will be heard and the display will change to "NO ERRORS". Press the "CLR" key to return to "TEST MODE", or the "A" key to proceed to "SELF TEST".

SELF TEST - Press key "C"

Allows the service technician to run a quick diagnostics of all solenoids and their associated harnesses and control board drivers.

Press the letter "C" on the keypad and the display will scroll "SELF TEST". Press the "*" key and the display will change to "TESTING" as the controller sends a low current pulse to each of the solenoids. The display will then change to "ERRS ##". Normal error indications are based on the machine's configuration. The normal indication for a 5 tray/9 column vender is "ERRS 9" and for a 5 tray/6 column vender is "ERRS 24". The display will then change to "SELF TEST". The service technician should list errors (item B in test mode) after Self Test. Press the "CLR" key to return to "TEST MODE" or the "A" key to proceed to "DISPLAY TEST".

DISPLAY TEST - Press key "D"

Allows the service technician to check all segments of the LED display unit. Press the letter "D" on the keypad and the display will scroll "DISPLAY TEST". Press and hold the "*" key and the display will alternate between all *'s and all "0." with decimal points. Releasing the "*" key will return to "TEST MODE".

KEYPAD TEST - Press key "E"

Allows the service technician to test any or all keypad keys. Press the letter "E" on the keypad and the display will scroll "KEYPAD TEST". Press the "*" key and the display will go blank, and then press each key on the keypad. After each entry the characters will shift into the display from right to left until the "CLR" key is pressed. The display will return to "TEST MODE".

AUTO SEQUENCE - Press key "F"

Allows the service technician to put the machine into automatic vend. An item will be vended every second, starting from A1 and running through the ninth selection on the bottom tray of the machine, then repeating until the service technician stops it by pressing the "CLR" key. Press the letter "F" on the keypad and the display will scroll "AUTO SEQUENCE". Press the "*" key, automatic vend will start and the display will show selection currently being tested. Press the "CLR" key to stop and return to "TEST MODE".

CAUTION: It is strongly recommended this feature only be used to check channels/solenoids on empty machines.

TUBE FILL/DISPENSE - Press key "1"

Allows the service technician to inventory currency in the coin mechanism escrow tubes and "Teach" the controller how many coins of each denomination are in that inventory. This allows for the maximum number of dollar bills to be accepted prior to enabling the "USE EXACT CHANGE" function. This also provides for exact cash accountability in the audit functions. This function can also be used as a diagnostic tool to insure the coin mechanism is responding properly. Press the number "1" on the keypad and the display will read "TUBEFILL/DISPENSE".. Press the "*" key and the display will show the lowest denomination accepted and the number of these coins inventoried (i.e. \$.05 - 6). Press the letter "A" on the keypad to scroll through the denominations available. With a given denomination displayed (i.e. \$.05 - 6), an inserted coin of this denomination via the coin chute will increase the inventory shown. Press the "*" key and the denomination displayed will be dispensed to the coin return cup and the inventory will be decreased. Note: When you insert any denomination the display will change to show the denomination inserted.

DAYLIGHT SAVINGS TIME - Press key "2"

Allows the service technician to enable daylight savings time to be set as it applies to the selected Daylight Savings Rules Setting. Press the "*" key to show the current DST setting. Press the "A" key to scroll through the different DST settings that are available. With the setting you wish to use showing on the display, press the "*" key.

- DST OFF – No Daylight Savings Time

- DST AMER - American Rules. If enabled, the VCU will set the clock back one hour on the last Sunday of October (2:00 AM), set the clock ahead one hour on the first Sunday in April (2:00 AM).
- DST EURO – European Rules. If enabled, the VCU will set the clock back one hour on the last Sunday of October (1:00 AM), set the clock ahead one hour on the last Sunday in March (1:00 AM).
- DST AUS – Australian Rules. If enabled, the VCU will set the clock back one hour on the last Sunday of March (1:00 AM), set the clock ahead one hour on the first Sunday in October (1:00 AM).

SET NOT AVAILABLE MODE - Press key “3”

This setting works in conjunction with the “SET NOT AVAILABLE TIME” (option 3 in setup mode). This setting must be showing “Cancel N” in order for the Not Available times to function as programmed. This mode can also be used to manually disable the times established in ‘SET NOT AVAILABLE TIME” mode as long as the function is set to “CANCEL Y” before the “SET NOT AVAILABLE TIME” starts. Press the number “3” on the keypad and the display will scroll “SET NOT AVAILABLE MODE” and then change to “CANCEL Y” or “CANCEL N”, depending on the current state. Factory default for this setting is “CANCEL N” Pressing the “*” key will toggle the state and set the controller to the new condition shown on the display (pushing the * key with CANCEL Y on the display will ALLOW the not available mode to function as programmed). Press the “CLR” key to return to “TEST MODE”.

SET CREDIT TIMER MODE - Press key “4”

Allows the service technician to set the vender to cancel a credit or keep a credit showing on the display after 5 minutes. Press the number “4” on the keypad and the display will scroll ‘SET CREDIT TIMER MODE” once, then the display will read “CANCEL Y” or “CANCEL N” depending on the current state. Pressing the “*” key will toggle the state. “CANCEL N” will save a credit indefinitely. “CANCEL Y” will only save a credit for five minutes. Press the “CLR” key to return to “TEST MODE”.

DOOR OPEN - Press key “5”

Shows number of times the service door has been opened since last “CLEAR TOTALS” or “MASTER RESET”. Press the number “5” on the keypad and “DOOR OPEN” will scroll across the display and then change to a #, which is the number of times the service door has been opened since the last “CLEAR TOTALS” or “MASTER RESET”. Use the “*” key to view the day, date, and time of the last opening. Press the “A” key to scroll through the last

5 openings. Press the “CLR” key to return to “TEST MODE”.

POWER OUT - Press key “6”

Shows the number of times the machine has lost power since last “CLEAR TOTALS” or “MASTER RESET”. (This is a power outage for any reason including the machine being unplugged or the machine’s master power switch being turned off). Press the number “6” on the keypad and “POWER OUT” will scroll across the display, then the display will show a #, which is the number of times power has been lost to the control board since the last “CLEAR TOTALS” or “MASTER RESET”. Use the “*” key to view the day, date, and time of the most recent power outage. Once the date is showing on the display, press the “A” key to scroll through the last five outages. Press the “CLR” key to return to “TEST MODE”.

TEST HEALTH GUARD - Press key “7”

This setting is in place to test the functioning of the health guard system by simulating a Health Code Error. Once activated, any selections programmed in “ENABLE HEALTH CONTROL” in the setup mode will be disabled. To test health guard, press the number 6 on the keypad and the display will scroll “TEST HEALTH GUARD”. Push the “*” key and the display will change to OK and an audible tone will be heard and the display will return to “TEST MODE”. Within one minute of returning the vender to service, items that were set in “ENABLE HEALTH CONTROL” setting in the SETUP MODE will be put out of service. Additionally, a “HEALTH G” error will be displayed in ‘LIST ERRORS. Errors must be cleared before programmed items can be returned to service. Note:. A Temperature Sensor must be installed for this function to work.

DISPLAY HEALTH GUARD - Press key “8”

Allows the service technician to view the selections that are listed under the “ENABLE HEALTH CONTROL” in the SETUP MODE. Press the number “8” on the keypad and the display will read “DISPLAY HEALTH GUARD”. Press and hold the “*” key and the selection(s) that are listed under the health control will be displayed or “END LIST” if no selections are listed. Releasing the “*” key will return to “DISPLAY HEALTH GUARD”.

TEST VEND - Press key “9”

Allows the service technician to test vend any item. Press the number “9” on the keypad and the display will read “TEST VEND”. Press the “*” key and the display will read “ITEM”. Select the item/column to be tested by pressing the corresponding keys on the keypad (i.e. A6) and the corresponding solenoid will cycle. Ensure that the glass door is closed if utilizing this function when product is loaded in vender. Press the “CLR” key to return to “SERVICE MODE”.

CLEAR ERRORS - Press key "0"

Allows the service technician to clear any recorded errors. Press the number "0" on the keypad and the display will scroll "CLEAR ERRORS". Press the "*" key and the display will read "OK" momentarily and an audible tone will be heard. The errors are cleared and the display returns to "SERVICE MODE".

SETUP MODE

Enter SETUP MODE by opening service door and pressing the Service button three times. The display will read "SETUP MODE".

NOTE: Several areas in the SETUP MODE are password protected. When entry into one of these areas is attempted the display will read "PW" if a password has been entered in the SETUP MODE. The password must be entered at this point before the service technician is allowed to proceed. The password need only be entered once during a service call provided the service door is not closed. If the door is closed and then re-opened, the password must be entered again before accessing a protected area. The factory default password is 0000. If the password is set at 0000 you will not be required to enter a password to access password protected modes. The display will show *'s as the password is entered. When the last character is entered, the display will read "OK", and then will shift into the requested area. If the display reads "BAD" after the last character is entered this means the password was not accepted.

NEXT ITEM - Press key "A"

ENTER MESSAGE - Key "B"

(PASSWORD REQUIRED)

Allows the entry of a custom idle message to replace the default idle message. Press the letter "B" on the keypad and "ENTER MESSAGE" will scroll across the display. Press the "*" key and the letter "A" will be displayed on the right side of the display. The program is now ready to accept the new message. The "A" key will move forward through the alphabet, numbers, space, punctuation marks, \$, AND a "L". The "B" key will move backwards through the same list. When the desired character is displayed on the right hand side of the display, press the "*" key. That character is now entered and the display moves to the left one space as the new message is built. When the new message is complete press the "CLR" key. This will return to "SETUPMODE".

CLEAR MESSAGE - Press key "C"

(PASSWORD REQUIRED)

Allows the service technician to clear any custom idle message and return to the default idle message. Press the letter "C" on the keypad and the display

will show "CLEAR MESSAGE". Press the "*" key and the display will read "OK" momentarily, an audible tone will be heard, and then will return to "SETUP MODE".

ENABLE DOLLAR SIGN - Press key "D"

(PASSWORD REQUIRED)

Allows the service technician to remove the dollar sign (\$) from the display when a product price, customer credit, or change due is displayed. When enabled, the dollar sign will appear in the display; when disabled it will not appear. Press the letter "D" on the keypad; the display will scroll "ENABLE DOLLAR SIGN" or "DISABLE DOLLAR SIGN". Pressing the "*" key will enable the state shown on the display, i.e. if the dollar sign is desired, and the display is reading "ENABLE DOLLAR SIGN", push the "*" key to enable dollar sign. Once the "*" key is pressed, the display will change to "OK" and an audible tone will be heard. The display will then change to "SETUP MODE". To return to "SETUP MODE" without changing state, press the "CLR" key.

CLEAR COOL DOWN - Key "E"

(PASSWORD REQUIRED)

Allows the service technician to stop a cool down period prior to the set time duration. Previously set in the service mode. Press the letter "E" on the keypad and "CLEAR COOL DOWN" will scroll on the display. Press the "*" key, the display will read "OK" momentarily, an audible tone will be heard and the display will return to "SETUP MODE". Note: All selections set to "COOL DOWN" are cleared.

MASTER RESET - Press key "F"

(PASSWORD REQUIRED)

Allows the service technician to restore factory defaults to the machine or reset the Controller Board's memory after reconfiguring a tray or installing a new EPROM. Since this feature resets resettable sales data, care should be taken prior to using. Press the letter "F" on the keypad and "MASTER RESET" will scroll across the display. Press the "*" key and the display will read "OK" momentarily and audible tones will be heard. The display will then return to the idle message. Please see table on next page for programming options effected by MASTER RESET. NOTE: A power out error message will be generated when a master reset is performed, however, the time and date will not be listed with it.

The table outlines the results of using MASTER RESET.

<u>ITEM</u>	<u>RESET TO</u>
CASH BOX	\$0.00
SALES	\$0.00
NUMBER SOLD	0
SALES PER COLUMN	0
ESCROW	ESCROW N

FORCE	FORCE N
AUDIO FEEDBACK	DISABLED
SET REGULAR PRICES	99.95
LIST ERRORS	Pwr Out
TUBE FILL/DISPENSE	CLEARED
DAYLIGHT SAVINGS	DISABLED
NOT AVAILABLE	CANCEL N
CREDIT TIMER	CANCEL N
DOOR OPEN	0
POWER OUT	0
DISPLAY HEALTH GUARD	GUARD
ENABLE DOLLAR SIGN	ENABLED
NOT AVAILABLE TIME	CLEARED
DISPLAY RESET	DISABLED
HEALTH CONTROL	DISABLED
DROP SENSOR	DISABLED
PASSWORD	0000
STS ENABLE	DISABLED
CUSTOM STS	CLEARED
VEND LIMIT	0
HEALTH RECHECK	DISABLED
RETRY LIMIT	DISABLED
SOLD OUT	ENABLED

MACHINE NUMBER - Press key "1"

(PASSWORD REQUIRED)

Allows assigning a user number to the machine for audit and/or inventory control requirements. Press the number "1" on the keypad and "MACHINE NUMBER" will scroll across the display and then change to the number currently assigned to the machine (i.e. ID 1). Press the "*" key and the display will read "ID". Enter the new number (numeric field, 4 characters maximum). If the new number is less than 4 characters press the "*" key after entering it and the display will read "OK" momentarily and will return to "SETUP MODE".

SET HAPPY HOUR - Key "2"

(PASSWORD REQUIRED)

Not available in software revisions 030.81 and higher.

Allows the service technician to set times and days for Happy Hour operation. Press the number "2" on the keypad and "SET HAPPY HOUR" will scroll across the display. Happy Hour start time, end time, and days of the week can now be programmed into the system. All times must be entered in military time format (24 hour clock). Setting Happy Hour is covered in detail in the INITIAL PROGRAMMING section of this manual. Press the "CLR" key to return to "SETUP MODE".

SET NOT AVAILABLE TIME - Press key "3"

(PASSWORD REQUIRED)

Password protected. Before entering or changing this setting you must enter the password if one has been assigned. This mode allows up to 4 different

time periods that use of the machine may be restricted. Refer to Initial Set Up section Set Not Available Times.

WINNER MODE - Press key "4"

(PASSWORD REQUIRED)

Not available in software revisions 030.81 and higher.

Allows the service technician to set the machine up to dispense a free product on a random basis. This mode CANNOT be made item selective. If the Winner Mode is set, each product in the machine is subject to being dispensed free. The winning customer is determined by the program picking a number at random from 1 to the winner mode set number. Inputting a 0 disables this mode. Press the number "4" on the keypad and "WINNER MODE" will scroll across the display then change to "WINR 0".

Enter a number from 1 to 255 and press the "*" key. The display will read "OK" momentarily. The mode will be set and the display will return to "SETUP MODE".

DATE/TIME - Press key "5"

Shows the day, date, and time setting currently in the system in following format: SUN 01/02/00 1330 Press the number "5" on the keypad, "DATE/TIME" will scroll once, then the day, date, and time will scroll across the display. Setting the day, date, and time is covered in detail in the INITIAL PROGRAMMING section of this manual. Press the "CLR" key to return to "SETUP MODE".

TOTAL SALES - Press key "6"

Shows total sales since machine manufacture or last MAS-TER RESET. This total is not cleared by CLEAR TOTALS. Press the number "6" on the keypad, the display will scroll "TOTAL SALES" then change to \$#.##. Press the "CLR" key to return to "SETUP MODE".

ENABLE HEALTH CONTROL - Press key "7"

Allows the service technician to select items to ENABLE HEALTH CONTROL. When enabled, if the temperature in the vender does not reach 41 degrees F within 30 minutes after the service door is closed, a "HEALTH TIME" error will occur and lockout the enabled selection(s) from vending until after the error is cleared. Also, if the temperature in the vender goes above 41 degrees F for more than 15 minutes after the initial cool down period, a "HEALTH CONTROL" error will occur and lockout the enabled selection(s) from vending until the error is cleared. Press the number "7" on the keypad and the display will scroll "ENABLE HEALTH CONTROL". Press the "*" key and the display will show 'ITEM'. There are now three choices:

1. **All selections.** Press the * key and all selections in the vender will now be set for

health control. The display will change to "ENABLED" then back to "ITEM".

- 2. One tray.** Pressing the letter of the shelf followed by the * key will set control for all selections on that shelf. For example, to control the A shelf push key "A" followed by "*" key. The display will change to "ENABLED" then back to "ITEM".
- 3. Single selection.** Press the desired selection number or numbers corresponding to the selections that require the health control function. After each selection is made the display will change to "ENABLED" then back to "ITEM".

Press the keypad buttons again and the display will flash "DISABLED" and return to "ITEM". Priority will be given to the higher ranked method. If one selection on the A tray was set to ENABLE using option 3 above and you wish to change the remaining selections on that tray using option 2, the Setting for the entire tray would take precedence. Conversely, if the tray was set using option 2 first followed by the single selection using option 3, the setting for the remainder of the shelf would remain and the new price for the single selection would change to the new value. Press "CLR" to return to "SETUP MODE".

DROP SENSOR ENABLED/DISABLED - Press key "8"

(PASSWORD REQUIRED)

Allows Enabling or Disabling of drop sensor Credit Guard function. When enabled, the customer will retain credit for the amount deposited if a product does not pass through the sensor beam in the recovery unit. This state will allow three attempts to vend a product before credit is lost. Both states will prevent a vend if a product is in the recovery unit. Press the number "8" on the keypad and "ENABLE DROP SENSOR" or "DISABLE DROP SENSOR" will scroll across the display. Pressing the "*" key will switch the state. Note: When the display shows enabled, the state is actually disabled. Press the "CLR" key to return to "SETUP MODE".

SET COOL TIME - Key "9"

Allows the service technician to vary the time duration of the cool down period from 0 to 255 minutes. If no time is entered here, and the SET COOL DOWN feature is started, the time duration of the cool down period will be 240 minutes (4 hours). To set the cool down time press the letter "D" on the keypad and the display will scroll "SET COOL TIME", and then change to "COOL 240". Use the keypad to enter the duration of the cool down period that you wish to use. Press the "*" key to enter your preferred time into memory. The display will read "OK" momentarily and return to "SETUP MODE".

ENTER NEW PASSWORD - Press key "0"

(PASSWORD REQUIRED)

Allows the service technician to enter a personalized password. IF YOU DECIDE TO CHANGE FROM THE DEFAULT PASSWORD, PLEASE ENTER THE NEW PASSWORD SLOWLY AND CAREFULLY!!! Press the number "0" on the keypad and "ENTER PASSWORD" will scroll across the display. Press the "*" key and the display will read "PW". Enter the password, the display will read "OK" momentarily then "NEW PW" will be displayed. Enter the new password. After the fourth character of the new Password is entered the display will read "OK" momentarily and return to "SETUP MODE".

SETUP MODE 2

Enter SETUP MODE 2 by opening the main door and pushing the Service button four times. The display will read "SETUP MODE 2"

NEXT ITEM - Press key "A"

SPACE TO SALES ENABLE/DISABLE - Press key "B"

Allows enabling or disabling the Space-to-Sales vend mode. When Enabled, Space-to-Sales vends are performed according to the configurations defined using "DEFAULT STS CONFIG" and/or "CUSTOM STS CONFIG".

Press the Letter "B" on the keypad. The display will scroll the current state of the Space-to Sales vend mode as "STS ENABLED" OR "STS DISABLED".

There are now two choices:

1. Press the "CLR" key to leave the Space-to-Sales vend mode unchanged and return to "SETUP MODE 2"
2. Press the "*" key to toggle the state. The display will scroll a new message indicating the updated state.

CUSTOM STS CONFIG - Press key "C"

Configures the Space-to-Sales according to user input.

Press the letter "C" on the keypad. The display will read "START". There are now 3 choices:

1. Pressing the "*" key will set STS to a one to one configuration such that each selection is mapped only to its corresponding column.
Note: This setting overrides any previously defined Space-to-Sales blocks.
2. Pressing a tray selection followed by "*" will configure an entire tray as a single Space-to-Sales block. Example is selections A1 through A9 vend from columns A1 through A9 sequentially.
3. Pressing an item selection (A1) will specify the first product of the Space-to-Sales block.

After the first item is programmed, the display will change to "END". Press the item selection corresponding to the last item in the block. This option may transcend more than one shelf, i.e. A1 to B9. Important Note: Any column number ending in the number "0" (ie A0, B0, C0, D0, E0) is not included in STS blocks. Example: A1 through B6 will not include A0. Also, if you use any column "0" for the end of a STS block, it will include all shelves and columns below it as the "0" columns are tied to the F tray port on the control board. Example: STS block A1 through B0 will actually include A1 through E0, but does not include A0.

In all of the above options, after a selection is made, an audible tone will be heard and the display will change briefly to "OK" then back to "START". Press "CLR" at any time to return to SETUP MODE 2.

DEFAULT STS CONFIG - Press key "D"

Configures the Space-to-Sales to the preset mappings.

Press "D" on the keypad and the display will scroll "DEFAULT STS CONFIG". Press the "*" key to configure Space-to-Sales in preset blocks of three (A1 – A3, A4-A6, A7-A9, B1-B3,...).

DISPLAY STS CONFIG - Press key "E"

Allows verification of the Space-to-Sales settings for an individual item.

Press the letter "E" on the keypad. The display will scroll "DISPLAY STS CONFIG". Press the "*" key and the display will change to "ITEM". Enter any selection item and the display will read "##-## ##". The first ## indicates the first column in the selection's block. The second ## indicates the last column in the selection's block. The last ## indicates the column that the next vend will come from in this Space-to-Sales block. For example, entering "A2" might display "A1-A3 A1", indicating that selection A2 is part of the block that spans between A1 and A3 and that A1 selection is next in line to be vend.

SET VEND LIMIT - Key "F"

Not available in software revisions 030.81 and higher.

If a Vend fails-either due to a vend error or no product detected in the recovery unit- and the drop sensor is enabled, the VMC will mark the column as sold out. If the Space-to-Sales is enabled, the product column will be removed from the Space-to-Sales rotation and the VMC will attempt to vend from the next column in the Space-to-Sales block. If the vender is unable to vend any products from a Space-to-Sales block, the customer's credit will be

returned and the entire block will be marked as "SOLD OUT".

Press the "F" key on the keypad. The display will scroll "SET VEND LIMIT". Press the "*" key while the display is scrolling, or wait until the message scrolls off. The display will read "LIMIT #". The value # is the current vend limit which is applied to each selection. When # is 0, no vend limits are enforced. Enter the desired vend limit and press the "*" key to accept this value or press the "CLR" key to cancel changes and return to SETUP MODE 2.

HEALTH RECHECK ENABLED/DISABLED - Press key "1"

When enabled, after a "HEALTH TIME" error has occurred, the vender will recheck the cooler compartment temperature 3 times in 15-minute intervals. If the temperature drops below 41 degrees, the "HEALTH TIME" error is cleared and selections are re-enabled. If any recheck reads above a previous reading, or if the temperature is not below 41 degrees by the third recheck, the "HEALTH TIME" error will remain and selections will continue to be blocked.

Press the number "1" key. The display will scroll "HEALTH RECHECK ENABLED" or "HEALTH RECHECK DISABLED". There are now 2 choices:

1. Press the "CLR" key to leave the Health Recheck setting unchanged and return to "SETUP MODE 2"
2. Press the "*" key to toggle the state. The display will scroll a new message indicating the updated state.



This setting is inconsistent with NAMA guidelines for health-controlled venders.

SET RETRY LIMIT - Press key "2"

This function provides the customer with an additional opportunity (opportunities) to make a selection after a failed vend. When a retry limit is set, credit remains on the vender and the customer may make additional selections until the retry limit is reached at which point credit is returned.

Press the number "2" key. The display will scroll "SET RETRY LIMIT". Then the display will read "LIMIT #". The value # is the current retry limit which is used after an initial failed vend. This means that a retry limit of 3 will allow the user a total of 4 selections: the initial selection plus 3 retries. After the limit is reached, credit is returned. To change the limit #, when "LIMIT #" is displayed press the # key(s) to enter the retry limit you desire to be set.

SOLD OUT ENABLED/DISABLED - Press key "3"

Controls sold out detection by the drop sensor. When enabled, a signal is sent to the VCU when the

drop sensor does not detect a selected item. That signal tells the VCU that the item selected is sold out and removes it from the STS block until the next time the vender is serviced.

Press the number “3” on the keypad. The display will scroll “SOLD OUT ENABLED” or “SOLD OUT DISABLED”. Press the “*” key to toggle the state to the desired setting or press “CLR” to exit without making changes and return to “SETUP MODE 2”

PRICE DISPLAY ENABLED/DISABLED - Key “4”

This setting controls whether the vender displays a price when a selection is made. Machines with a card reader capable of displaying selection prices may be configured to prevent displaying prices on two separate displays. Press the number “4” on the keypad. The display will scroll “PRICE DISPLAY ENABLED” or “PRICE DISPLAY DISABLED”. Press the “*” key to toggle the state or press the “CLR” key to exit without making changes and return to SET UP MODE 2.

SENSOR OVERRIDE ENABLED/DISABLED –

Press key “5”

This should only be used under the direction of Dixie-Narco Technical Service. Press key 5 and the display will scroll “SENSOR OVERRIDE ENABLED or DISABLED” depending on current state. Press the “*” key to toggle the state of the setting. With the display showing the state you wish to use press the “CLR” key to exit. When enabled the controller will temporarily ignore the vend sensors that may become blocked from condensation immediately after the vender as been filled. The controller will ignore the vend sensor for up to 3 minutes from the time the service door is closed. If the sensor remains clear continuously for 30 seconds the controller will return to normal operation. During the override period, any vends performed will be treated as successful vends regardless of the Drop Sensor setting, except in the case of a solenoid error. Note that after 3 minutes, a blocked sensor will effectively prevent any new vends from being started.

INTERVAL CLEARING IS ON/IS OFF – Press key “6”

This function is used to indicate the state of the interval clearing setting. Press the number “6” key and “INTERVAL CLEARING IS ON or OFF” will scroll across display depending on the current

setting. When “ON”, the interval (resettable) data to automatically be cleared upon successful completion of a DEX audit. When “OFF” it allows for remote auditing devices that clear resettable data manually to be used to clear the data. Press the “*” key to accept the displayed setting, press the “CLR” key to exit the menu.

SET LIGHTS OFF – Press key “7”

The function is used to set the Date and Day when Lights will be turned OFF. Press the number “7” key and “SET LIGHTS OFF” will scroll across display. Press the “*” Key. “START TIME” will display, then “HOUR 00” will display. Use the Keypad enter time then press “*” key. “MIN 00” will display. Use the Keypad enter time then press “*” key. “SUN N” will display. Use the “A” key to toggle “N” for No or “Y” for Yes. Press the “*” Key, the next day will appear. Repeat for all days. Press “CLR” to exit.

SET REFRIGERATION TEMP – Press key “8”

This function is used to set product Temperature. Press the number “8” key and “SET REFRIGERATION TEMP” will scroll across display then “DEG F 35” will display. Use the keypad to enter the Temperature setting in degrees F. Press the “*” key to accept. “OK” will appear briefly. Press the “CLR” key to exit.

SET STORAGE TIME – Press key “9”

This function is used set the Date and Day when Storage Temperature will be ON. Press the number “9” and “SET STORAGE TEMP” will scroll across display. Press the “*” Key and “START TIME” will display, then “HOUR 00” will display. Use the Keypad to enter time then press “*” key. “MIN 00” will display. Use the Keypad enter time then press “*” key. “MIN 00” will display. Use the Keypad enter time then press “*” key. “SUN N” will display. Use the “A” key to toggle “N” for No or “Y” for Yes. Press the “*” Key, the next day will appear. Repeat for all days. Press “CLR” to exit.

SET STORAGE TEMP – Press key “0”

This function is used to set Storage Temperature. Press the number “0” key and “SET STORAGE TEMP” will scroll across display then “DEG F 65” will display. Use the keypad to enter the Temperature setting in degrees F. Press the “*” key to accept. “OK” will appear briefly. Press the “CLR” key to exit.

The most important facets of proper care and maintenance of your machine are the electrical power supplied to it, leveling, and cleanliness of the machine.

POWER

The machine must be connected to a dedicated 120 VAC, 15 Amp circuit (U.S. and Canada). Refer To the cabinet serial number plate to determine the proper voltage and frequency the machine requires.

CAUTION:

REMOVE POWER TO THE AC DISTRIBUTION BOX BEFORE CLEANING OR WHEN ANY ELECTRICAL COMPONENTS ARE CONNECTED/DISCONNECTED FOR TESTING OR REPLACEMENT

CLEANING

DO NOT USE A WATER JET OR NOZZLE TO CLEAN THE VENDER

GLASS DOOR

The display glass should be cleaned inside and out with paper towels and glass or non-abrasive all-purpose cleaner. The gasket around the product door should be wiped down using warm water, any mild general purpose, non-abrasive cleaner and a soft towel. Never lubricate the gasket and always check for cracking or deformities which may cause leaks. Replace if necessary.

TRAYS / TRAY INSERTS

The trays and tray inserts should be cleaned periodically using warm water and a mild general purpose, non-abrasive cleaner. Care should be taken to ensure water does not enter the solenoids. **DO NOT USE SOLVENTS OR ABRASIVE MATERIALS TO CLEAN ANY PORTION OF THE TRAY.**

SLIDE/PUSHER ASSEMBLY

The slide/pusher assembly should be cleaned periodically using warm water and any mild general-purpose non-abrasive cleaner. After drying, the slide assembly needs to have a coat of Armorall applied. Care should be taken to ensure liquid does not enter solenoids. **DO NOT USE SOLVENTS OR ABRASIVE MATERIALS TO CLEAN ANY PORTION OF THE TRAY.**

CABINET

Wash the cabinet with a good detergent or soap mixed in warm water. Wax the vender often with a good grade of automobile wax. Any corrosion inside the vender should be removed with fine steel wool and the area should be painted with

white paint. Repair any scratches on painted surfaces to prevent corrosion.

RECOVERY UNIT

Cleaning of the product delivery bin and condenser area requires removal of the product delivery bin.

To remove:

Open the service door.

Open the product door.

Pull the bin straight out until clear of the machine and set aside.

When installing, make sure the recovery unit is pushed all the way back before closing the product and service doors.

DRAIN PAN, DRAIN TUBE, AND DRAN HOSE

To prevent mold and mildew growth, and to avoid personal injury or property damage, the drain pan, drain tube, and drain hose must be properly aligned and routed. Ensure nothing obstructs the drain tube or drain hose and that the hose is not bent, pinched, or twisted in such a way as to prevent the flow of condensate. Periodically inspect the drain pan, drain tube, and drain hose for alignment and the presence of dirt, debris, mold, and mildew. Clean as needed.



WARNING

THE COMPRESSOR ELECTRICAL CIRCUIT IS ALWAYS LIVE WHEN THE PLUG IS CONNECTED TO AN ELECTRICAL OUTLET.

REFRIGERATION CONDENSER

Clean the condenser periodically of dirt or lint build-up. Remove the build up with a brush or vacuum, or blow the dirt out of the condenser with compressed air and approved safety nozzle. Ensure nothing obstructs air intake at the bottom of the main door. Ensure nothing obstructs air exhaust at the rear of the cabinet.

COIN ACCEPTOR

Follow the Coin Acceptor Manufacturer's instructions.

LUBRICATING THE VENDER

The vender refrigeration system does not require any field lubrication. The hermetic refrigeration system and fan motors are manufactured with lifetime lubrication.

EPROM REPLACEMENT

Software changes / upgrades are accomplished by changing the EPROM on the Control Board.
Remove power to the AC Distribution Box and proceed as follows:

Remove the cover from the Control Board (if one is present).

Remove the Battery clip to allow the Board's memory to drain. (Leave the clip off for a minimum of 10 minutes.)

Replace the EPROM. (The EPROM's legs bend easily. Remove and replace very carefully.)

Replace the Battery clip and cover (if used).

Apply power to the AC distribution box.

Go in the "Setup Mode" and push "F" for Master Reset.

Go in the "Test Mode" and push "0" to clear errors.

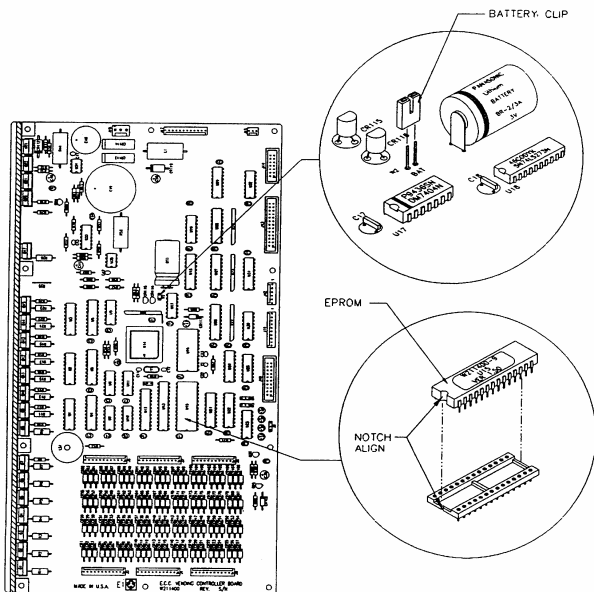

FIGURE 1 - EPROM REPLACEMENT ENTRY

AC DISTRIBUTION BOX

DN55###/54###/DN2145
110 VAC and 220 VAC units

Main Power Switch / Plug	Interrupts hot side of incoming power to all components in machine.
15 Amp Outlet (110 VAC) 15 Amp Outlet (220 VAC)	Provides power to refrigeration unit.
Transformer (T1)	Provides 24 Volt and 12 Volt (center tap) power to the Controller Board.
Fuse (X2 Center)	2 Amp SloBlo; protects primary of T1.
Fuse (X3 Left Side)	10 Amp, 32 Volt, SloBlo; protects 24 Volt input to Controller Board from secondary of T1.
Fuse (X4 Right Side)	2 Amp, SloBlo; protects 12 Volt input to Controller Board from secondary, center tap of T1.

Varistor Across incoming AC power to remove large power spikes.

REFRIGERATION UNIT

DN55###/54###
DN2145 (Roll-Up)
110 VAC and 220 VAC units

Compressor	Tecumseh, 1/2 HP, 115 VAC, 60 Hz, 1 Phase AK168AT-032-B4 Tecumseh, 1/2 HP, 220 VAC, 50 Hz, 1 Phase AK168JT-032-B4 Roll-Up unit uses 13 oz. of 134A refrigerant Model 1620CA ½ HP T6213Z-220-230/50
Start Relay	110 VAC - Tecumseh, 90701 220 VAC - Tecumseh, 90701-1 Double Pole, 115 VAC Model 1620CA TI 9660-041-158
Start Capacitor	110 VAC - CGE 01A4D160161NNTC 165 VAC, 161-193MFD 220 VAC - Phillips, 3535 B6A0072A330A3 330 VAC, 72 - 88 MFD Model 1620CA 88-108MFD / 250V 50HZ
Thermal Overload	110 VAC - Klixon, CRT 16AGN-130 220 VAC - Klixon, 12D6L Model 1620CA 220 VAC TI MRP20APK-34
Condenser Fan	Motor - Morrill Motors 110 VAC - SPGE9HB1 220 VAC - SPGE9HEM2 Blade - Roll-Up, 8" dia., 40° pitch Model 1620CA 8", 9W, 220 NT / 50
Evaporator Fan	Motor - Morrill Motors 110 VAC - SPGE9HBV1 220 VAC - SPGE9HMV2 Blade - 8" dia., 20° pitch

AC DISTRIBUTION BOX

DN35##

110 VAC and 220 VAC units

Main Power Switch / Plug	Interrupts hot side of incoming power to all components in machine.
15 Amp Outlet (110 VAC) 15 Amp Outlet (220 VAC)	Provides power to refrigeration unit.
Transformer (T1)	Provides 24 Volt and 12 Volt (center tap) power to the Controller Board.
Fuse (X2 Center)	2 Amp SloBlo; protects primary of T1.
Fuse (X3 Left Side)	10 Amp, 32 Volt, SloBlo; protects 24 Volt input to Controller Board from secondary of T1.
Fuse (X4 Right Side)	2 Amp, SloBlo; protects 12 Volt input to Controller Board from secondary, center tap of T1.

Varistor Across incoming AC power to remove large power spikes.

REFRIGERATION UNIT

DN35##

110 VAC and 220 VAC units

Compressor	Aspera, 1/2 HP, 115 VAC, 60 Hz, 1 Phase T6213Z Unit uses 13 oz. of 134A refrigerant Model 1620CA ½ HP T6213Z-220-230/50
Start Relay	110 VAC – T1 9660-041-180 Double Pole, 115 VAC
Start Capacitor	110 VAC - 189227
Thermal Overload	110 VAC - TI MST16AFN-3001
Condenser Fan	16W Motor 110 VAC – FV100CW25S Blade - 10" dia.
Evaporator Fan	Motor 110 VAC - SPGE9HBV1 Blade - 8" dia.

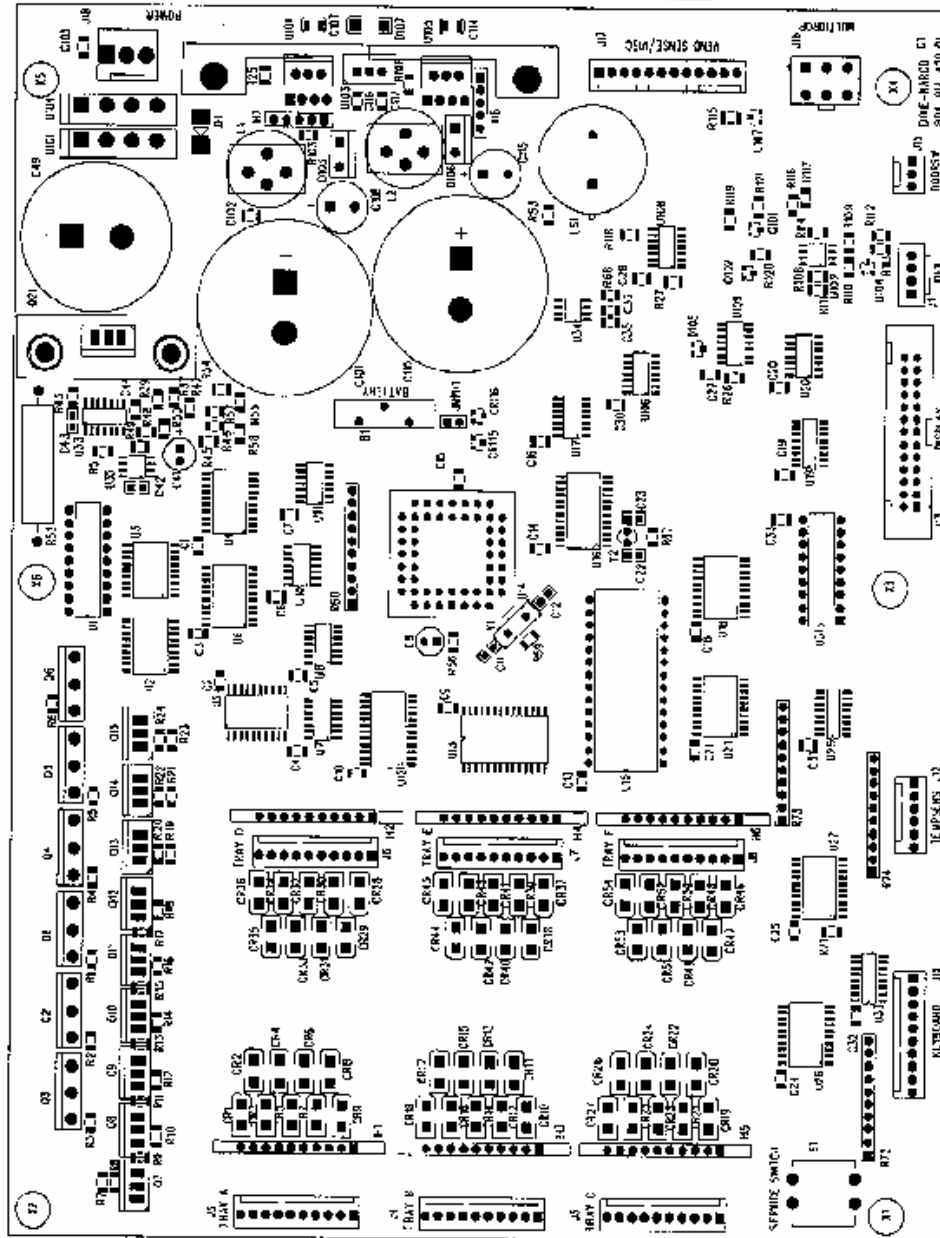
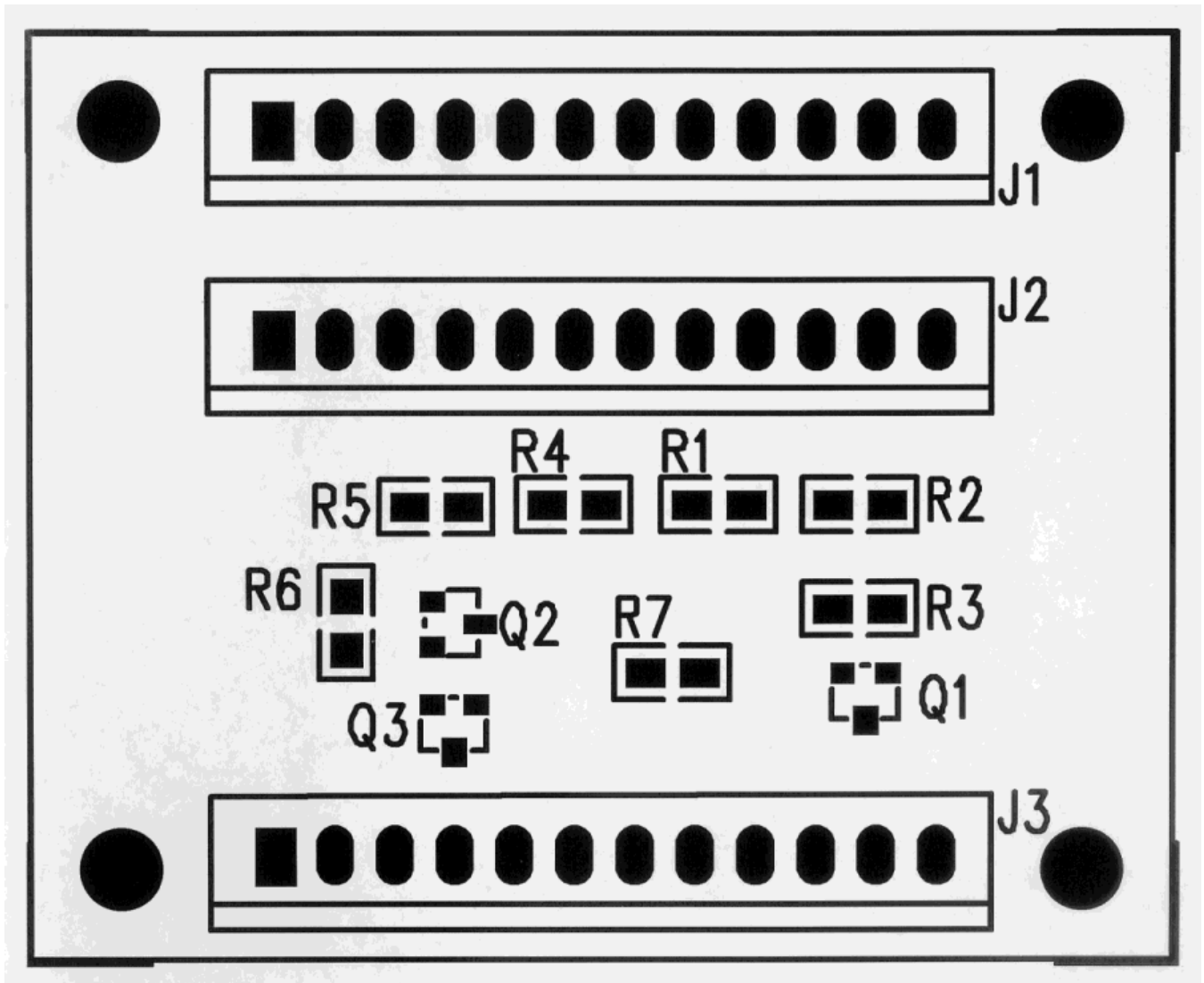

FIGURE 2 – MDB CONTROLLER CONNECTIONS
DN 59## / 54## / 39## SERIES

ITEM #	CONNECTION	DESCRIPTION
1	J18	Power from AC Distribution Box
2	J17	Vend Sensor
3	J16	Multi Drop Bus
4	J15	Door Interlock Switch
5	J13	Digital Display
6	J12	Temperature Sensor
7	J11	Keypad
8	TRAYS	Bottom Row J3 – A, J4 – B, J5 – C, TOP ROW J6 – D, J7 – E, J8 – F
9	J1	DEX



DUAL SENSOR BOARD (NON ENERGY STAR)

ITEM #	CONNECTION	DESCRIPTION
1	J1	Vend Sensor
2	J2	Vend Sensor
3	J3	Jumper from Main Board
4	J4	Temp Sensor (On Energy Star only)

COIN ACCEPTANCE ISSUES

PROBLEM	CAUSE	FIX
Coins Returned to Customer With No Credit Issued	<ol style="list-style-type: none"> 1. Coin Jam in Mech 2. Flight Deck Dirty 3. No Power to Mech 4. Coin Return Lever Activated 5. Vender in Test Mode 6. Not Available Time Set 7. Defective Coin Mech 	<ol style="list-style-type: none"> 1. Clear Jam and Test 2. Clean Flight Deck 3. Check Harness, Changer to VCU 4. Adjust Coin Return Lever 5. Close Service Door 6. Disable Not Available Time 7. Replace Mech
Will Not Payback Coins	<ol style="list-style-type: none"> 1. No Power to Mech 2. No Coins in Tubes 3. Tubes Programmed Incorrectly (4 Tube Mech) 4. Defective Coin Mech 	<ol style="list-style-type: none"> 1. Check / Replace MDB Harness 2. Fill Coin Tubes with Coins 3. Reprogram per Manufacturer Recommendation 4. Replace Coin Mech

DOLLAR BILL ACCEPTANCE ISSUES

PROBLEM	CAUSE	FIX
Bill Validator will not run.	Prices / tube cash conditions.	Check Mech Tubes.
Takes Bill in Then Rejects it		Check Validator or Replace
Stacks Bill While in Escrow Mode	Max Price Not Yet Reached	
Bill Error Listed in Test Mode	Communication Error with Bill Validator. Bill Validator Reported Error.	
Takes Bill, Gives No Credit	Board, Harness, Validator	Check or Replace Validator Harness, Replace Board

CONTROL BOARD (VCU)

PROBLEM	CAUSE	FIX
No Power to Controller.	1. AC Box	1. Replace AC box.
??????? Showing on Display	<ol style="list-style-type: none"> 1. Incorrect Input to Controller 2. Low or Missing 24 Volts 	
Out of Order or other error codes showing on display	RAM Error	Refer to Programming Section on page 14 for specific error codes and cures.
Temp out of Service	No Vendable Selections	

These charts are intended as a guide to isolate and correct most problems you might encounter. Should your machine scroll 'OUT OF SERVICE', go in the TEST MODE and press "B" to list errors.

ALL COINS ARE REJECTED

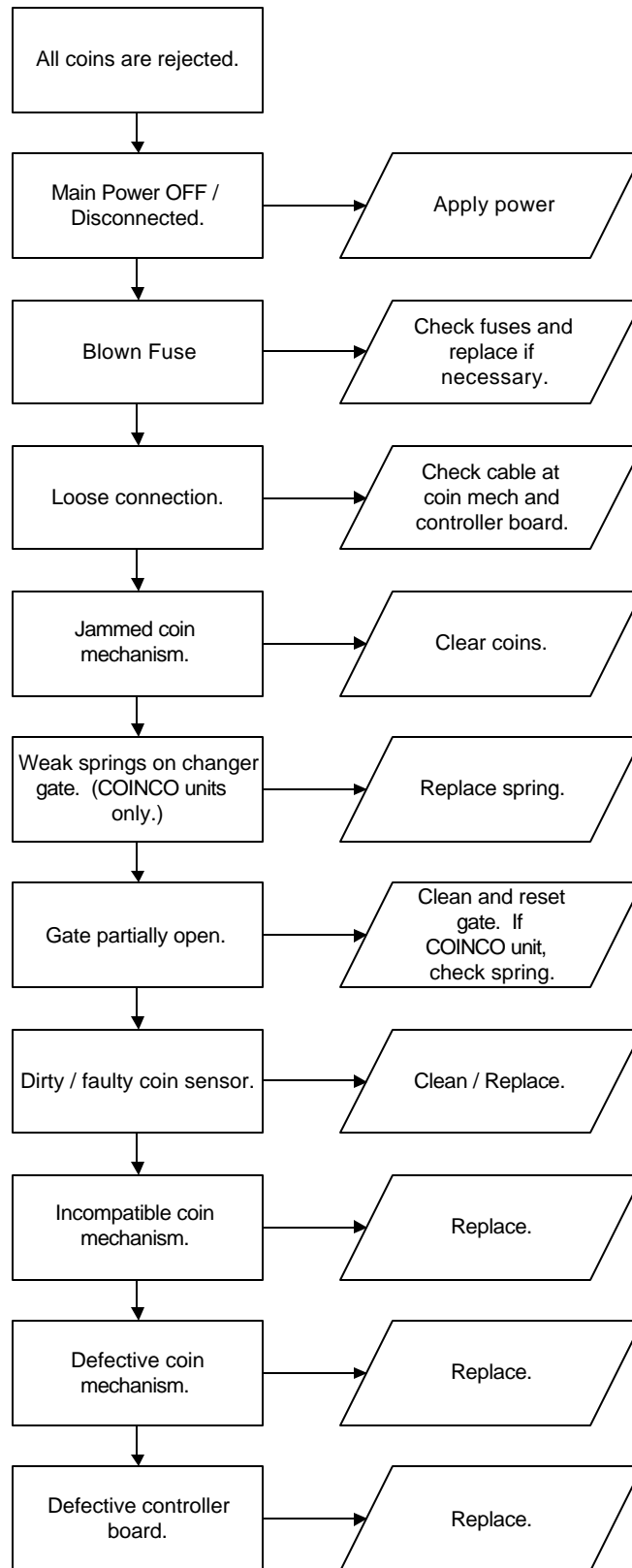

ALL BILLS ARE REJECTED

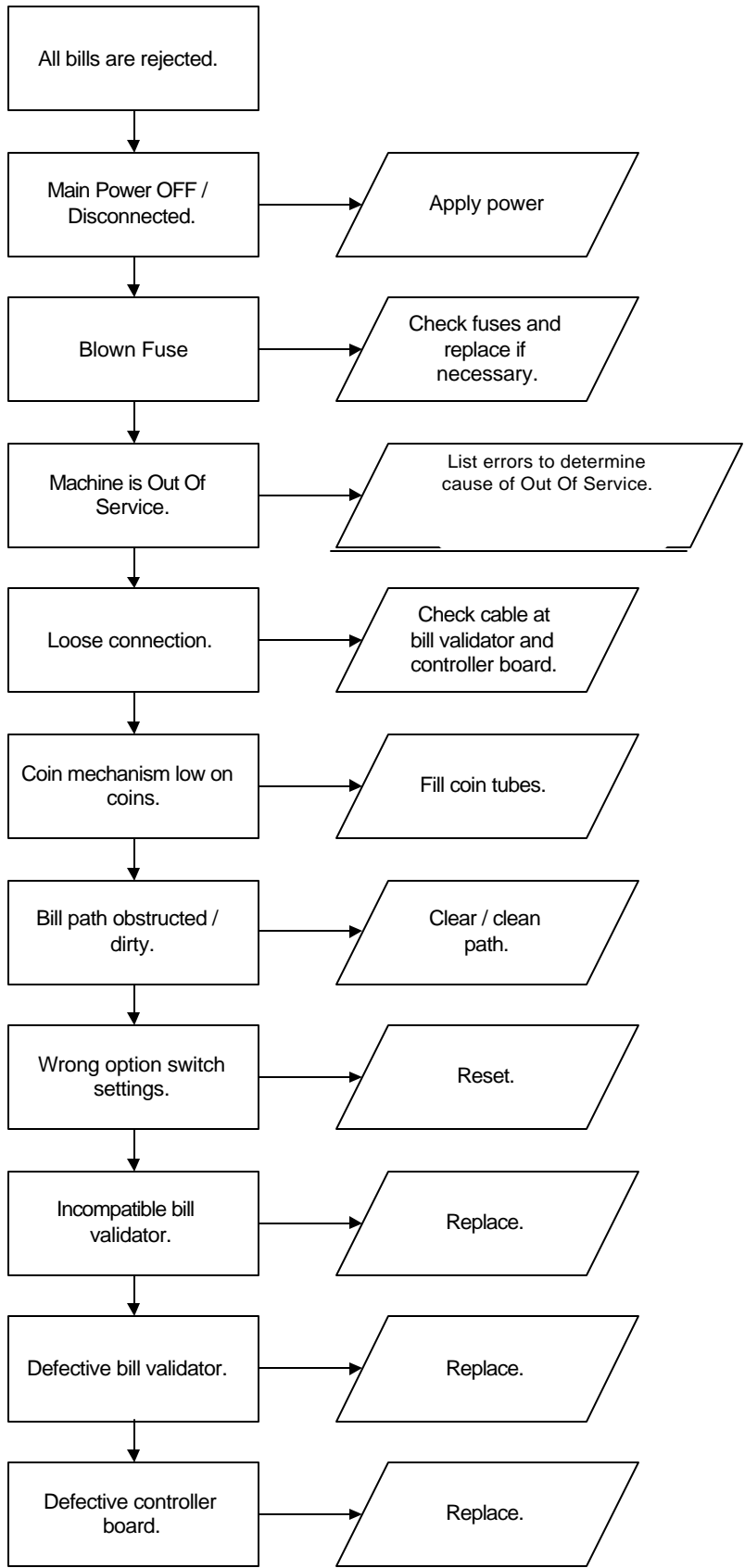

INCORRECT CHANGE DISPENSED

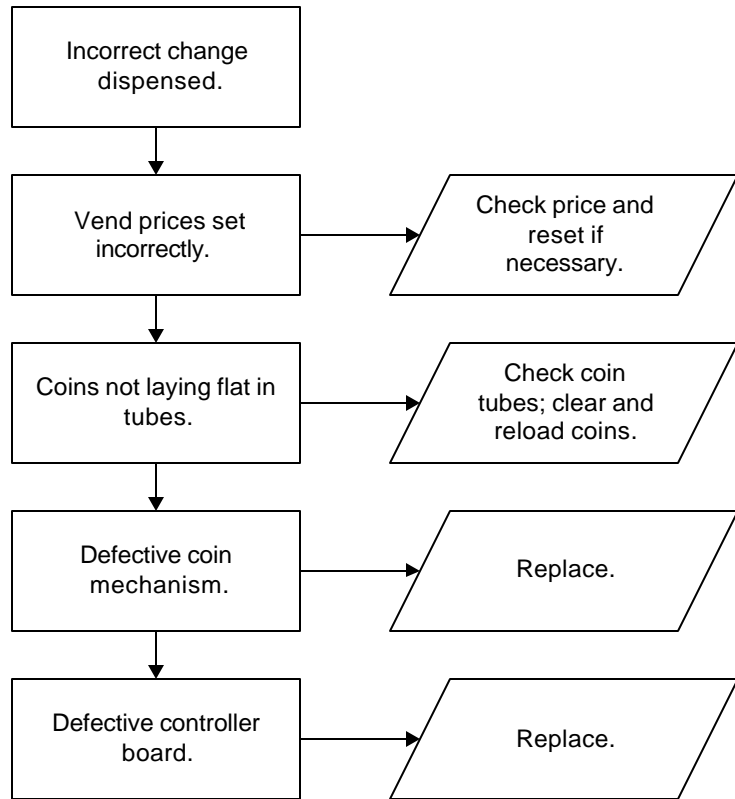

SELECTION WILL NOT VEND

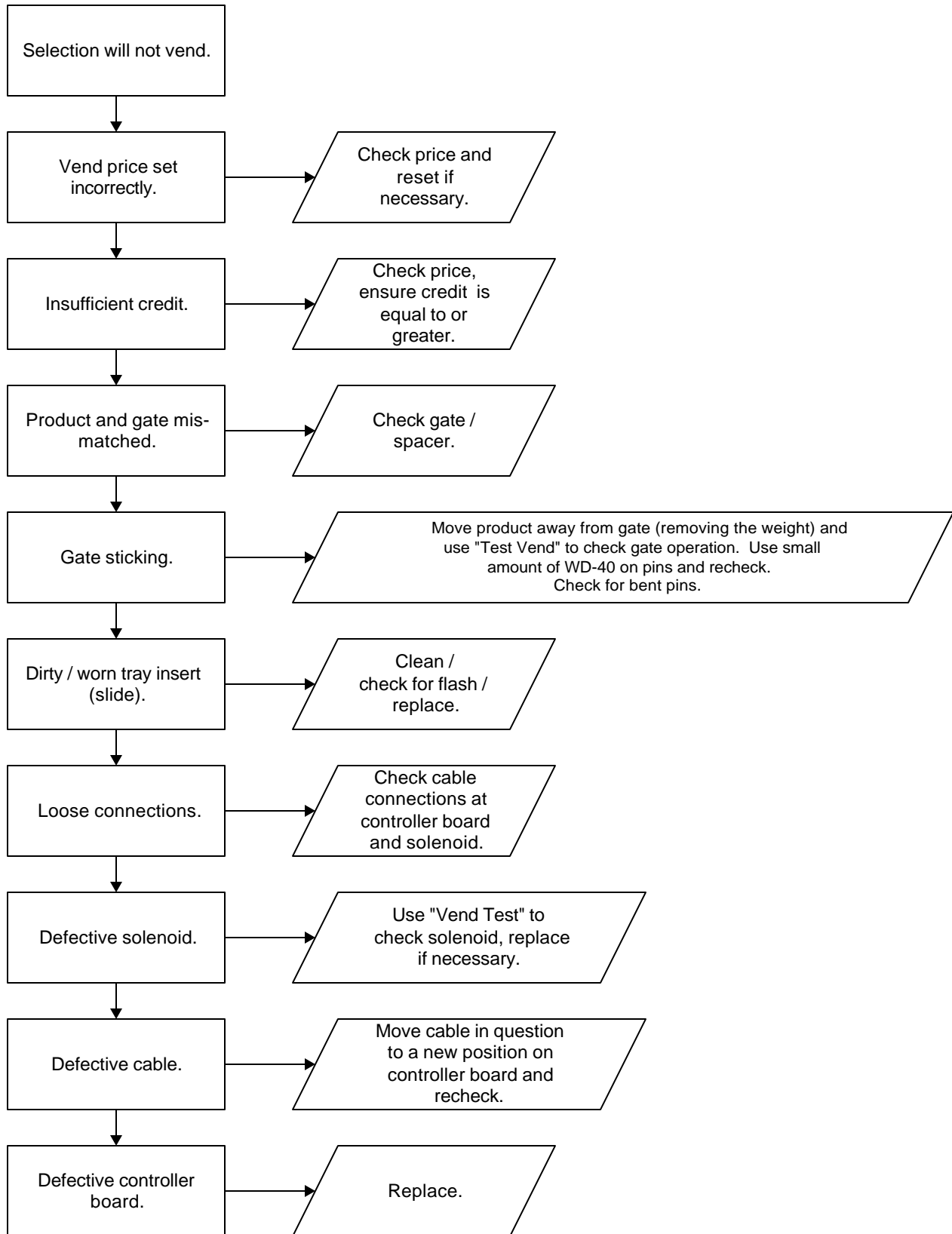

ICE / FROST ON EVAPORATOR

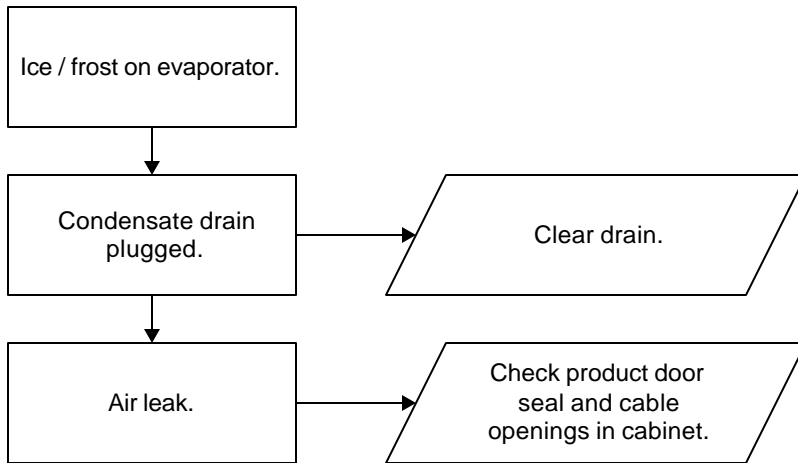

CONDENSATE ON OUTSIDE OF PRODUCT DOOR

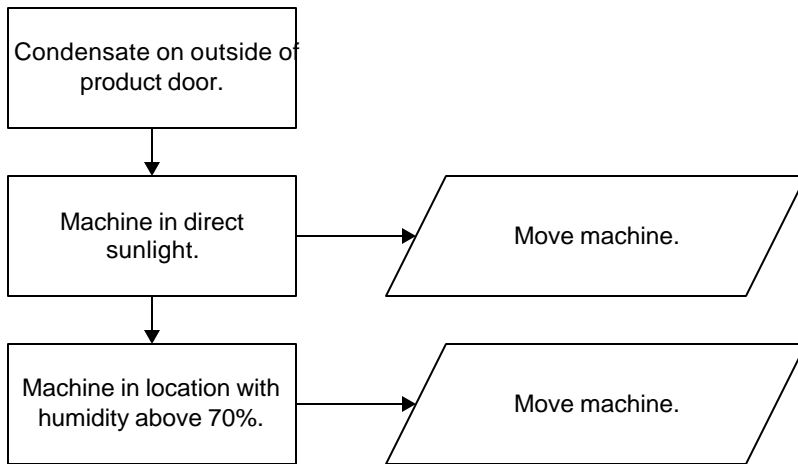

COMPRESSOR WILL NOT STOP

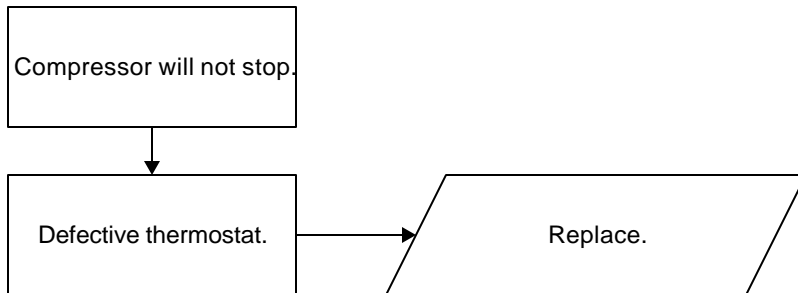

COMPRESSOR WILL NOT START

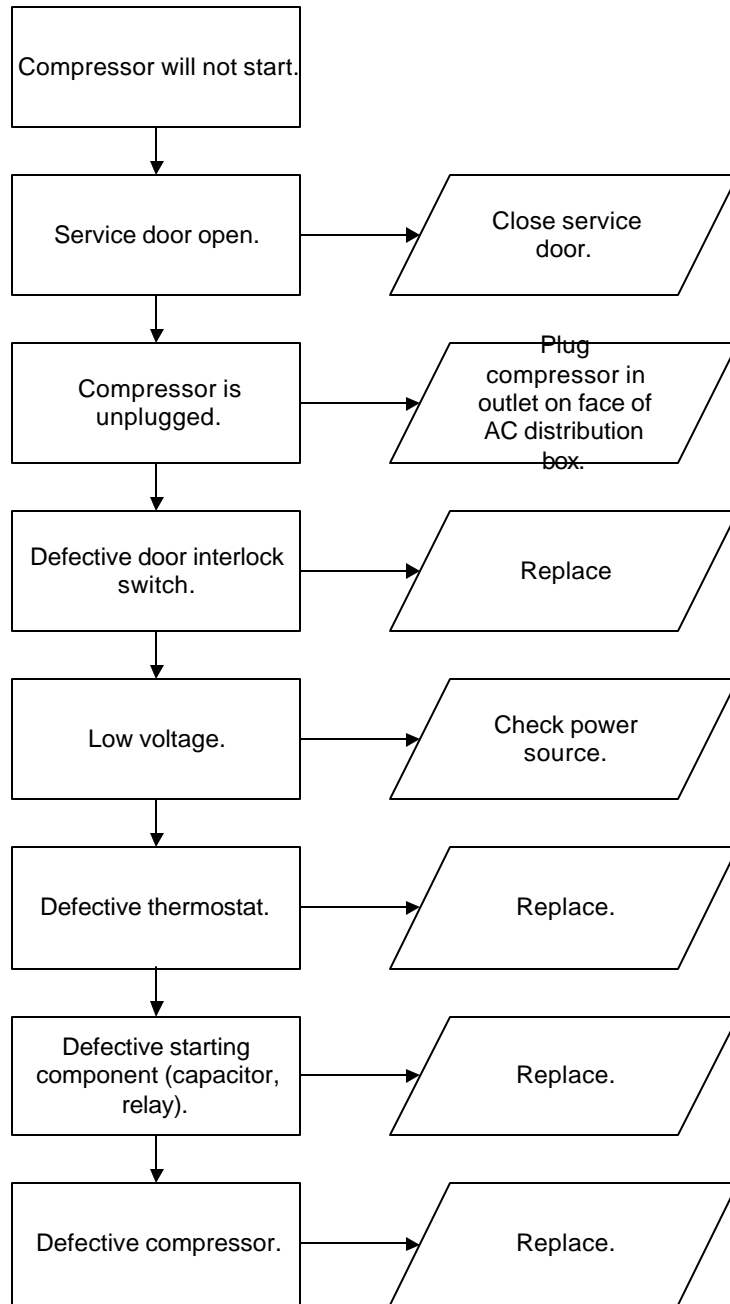

Troubleshooting Tip: Use a short 15 Amp extension cord and plug the compressor directly into the wall outlet. This will bypass the AC distribution box.
Note: For Testing Purposes Only.

MACHINE NOT COOLING

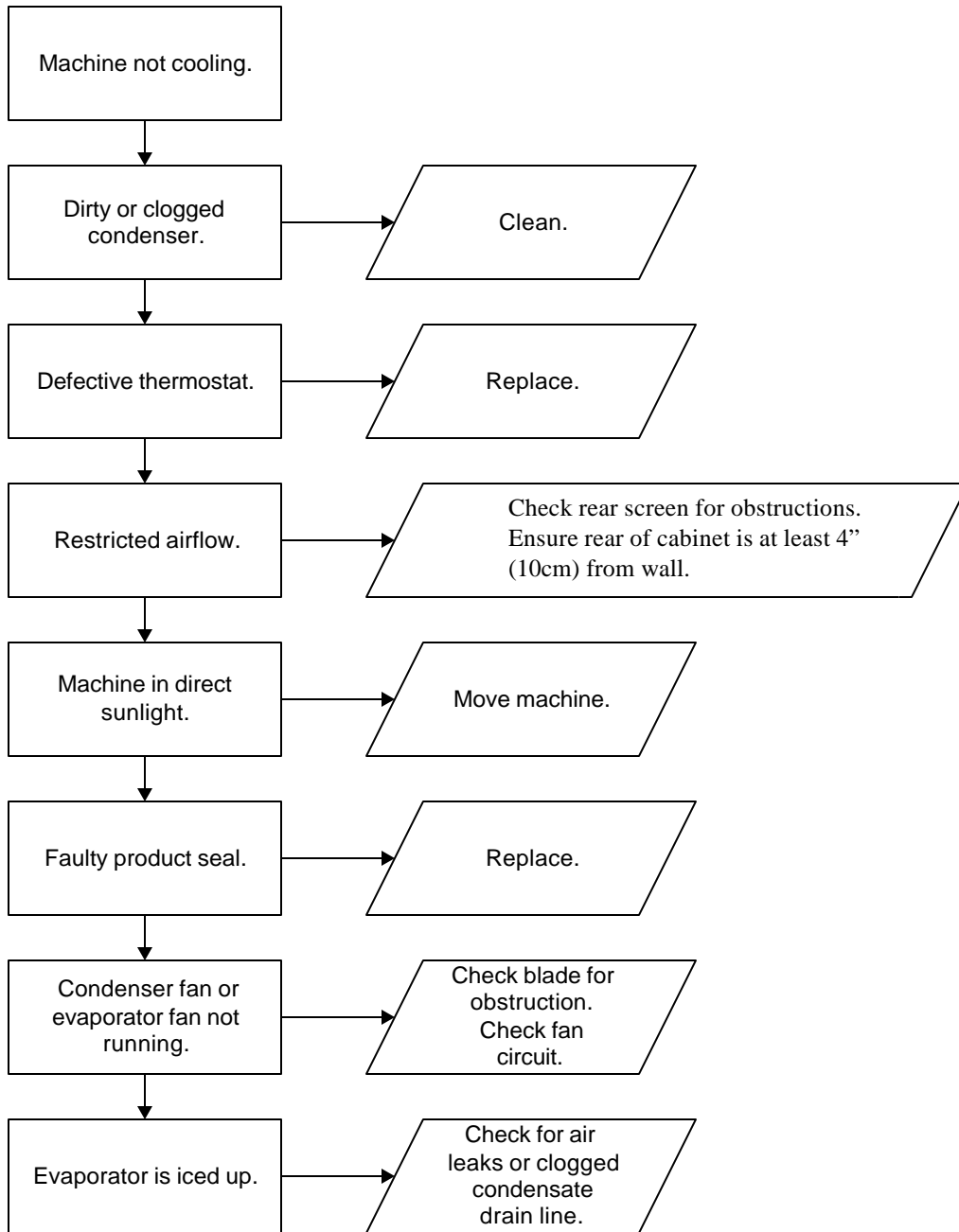

TROUBLESHOOTING “SELECTION WILL NOT VEND” ISSUES

1. Selection will not vend
 - a. Does a different selection vend?
 - i. Shelf harness swapped
 1. Perform TEST VEND in TEST MENU ensure proper selection vends
 - ii. Space-To-Sales has been enabled
 1. Check STS configuration in SETUP MENU 2
 - b. Did the gate actuate at all?
 - i. Gate “rattled” or solenoid clicked, but gate did not fully actuate
 1. Gate Sticking
 - a. Shuttle bad
 - b. Bent pins
 - c. Front knuckle pin not connected to solenoid
 2. Possible Solenoid drive problem
 - a. Check error list. Does list show “LOW LINE” or “LOW 28V”?
 - i. Bad AC box
 - ii. Bad electrical supply to vender
 - iii. Defective board
 - b. Check error list. Does list show “VEND ERR”, with selection included in vend error list when pressing “A”?
Perform vend test on selection. Does vend test report “HC+” or “HC”, or “LC”, or “NC” instead of “OK”?
 - i. Only occurs on one solenoid
 1. Defective solenoid
 2. Solenoid-harness connection
 - ii. Occurs on entire shelf
 1. Harness issue
 2. Defective board
 3. Bad AC box
 4. Bad electrical service to vender
 - iii. Occurs on same column, multiple shelves (A2, B2, C2, D2, E2)
 1. Defective board
 2. Bad AC box
 3. Bad electrical service to vender
 - ii. Gate did not rattle or solenoid did not click
 1. Software attempted vend
 - a. Check error list. Does error list show “LOW LINE” or “LOW 28V”?
 - i. Bad AC box
 - ii. Bad electrical service to vender
 - b. Check error list. Does error list show “VEND ERR”, with selection included in vend error list when pressing “A”?
Perform vend test on selection. Does vend test report “HC+” or “HC”, or “LC”, or “NC” instead of “OK”?
 - i. Only occurs on one solenoid
 1. Defective solenoid
 2. Solenoid-harness connection
 - ii. Occurs on entire shelf
 1. Harness issue
 2. Defective board
 3. Bad AC Box
 4. Bad electrical supply to vender
 - iii. Occurs on same column, multiple shelves (A2, B2, C2, D2, E2)
 1. Defective board
 2. Bad AC box
 3. Bad electrical service to vender

- ii. Gate did not rattle or solenoid did not click (continued)
 - 2. Software did not attempt to vend
 - a. Check error list. Does error list show "VEND ERR", with selection included in vend error list when pressing "A"?
 - i. A previous vend operation, vend test, or self test indicated a solenoid error
 - b. Software has selection identified as "sold out"
 - i. Drop sensor is enabled, column is empty
 - 1. Refill selection
 - 2. Disable drop sensor
 - ii. Drop sensor is enabled, product was not detected by drop sensor on a previous vend
 - 1. Ensure software is 030.51 or greater
 - 2. Cycle door to reset sold outs
 - 3. Realign sensor(s) to catch product
 - 4. Disable drop sensor
 - c. Selection is placed under SETUP MODE, HEALTH GUARD
 - d. Selection is placed under SERVICE MODE, SET COOL DOWN function.
 - e. Selection has been disabled through SERVICE MODE, ENABLE ITEM function
 - f. SETUP MODE 2, VEND LIMIT function set to non-zero value.
 - i. Cycle door to reset vend limits / sold out
- iii. Gate did actuate
 - 1. Product and gate mismatch
 - a. Check correct spacer used
 - 2. Dirty / worn tray slide with pusher
 - a. Check slide with pusher

DN55## VENDER NON ENERGY STAR (Beverage Max Diagram 9 Column)

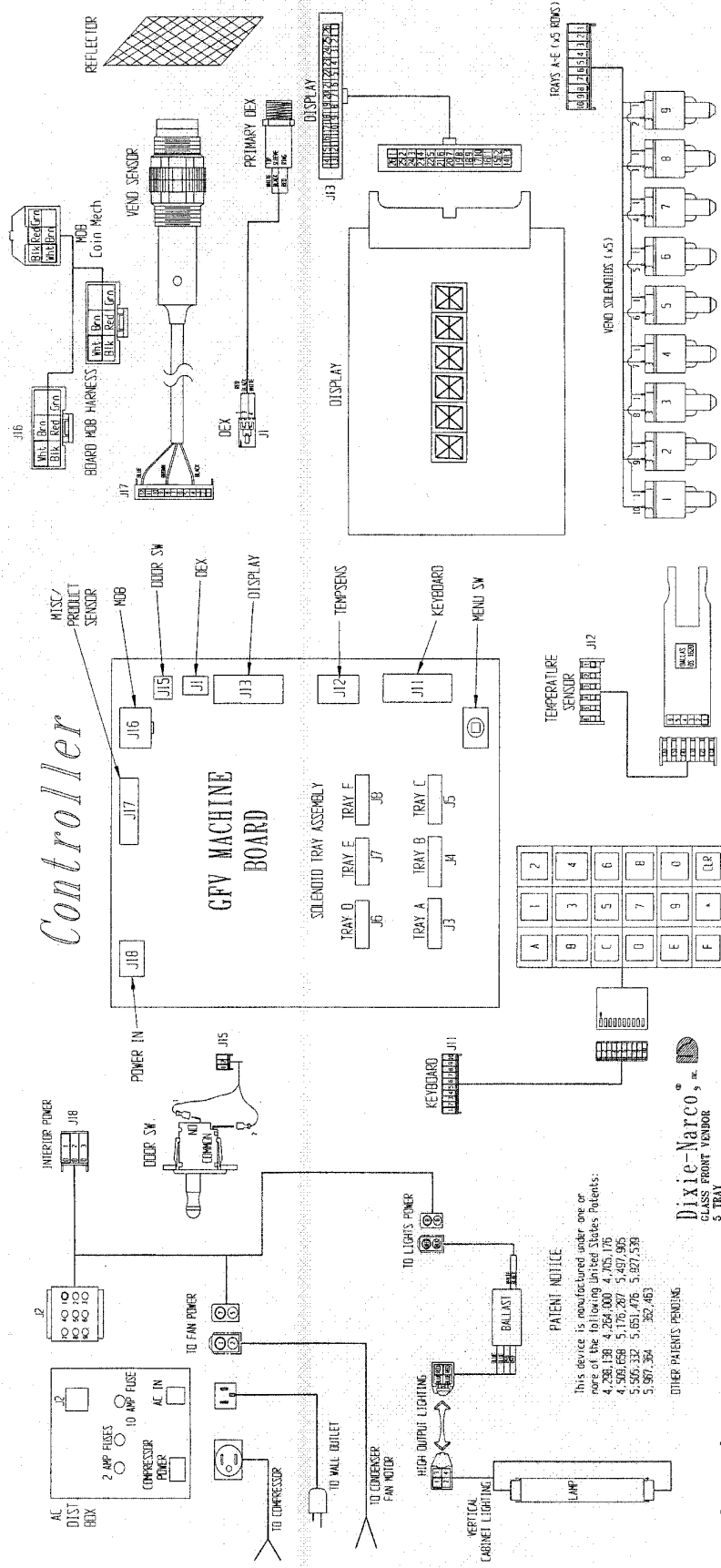

PATENT NOTICE
 This device is manufactured under one or more of the following United States Patents:
 4,280,138; 4,264,000; 4,705,176;
 4,391,658; 5,176,287; 5,457,985;
 5,556,332; 5,651,476; 5,927,338;
 5,897,354; 362,463
 OTHER PATENTS PENDING

Dixie-Narco, Inc.
 CLASS FRONT VENDOR
 5 TRAY

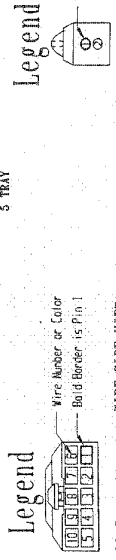

All Connectors are WIRE SIDE VIEW

DN55## ENERGY STAR VENDER
 (Beverage Max Diagram 9 Column)

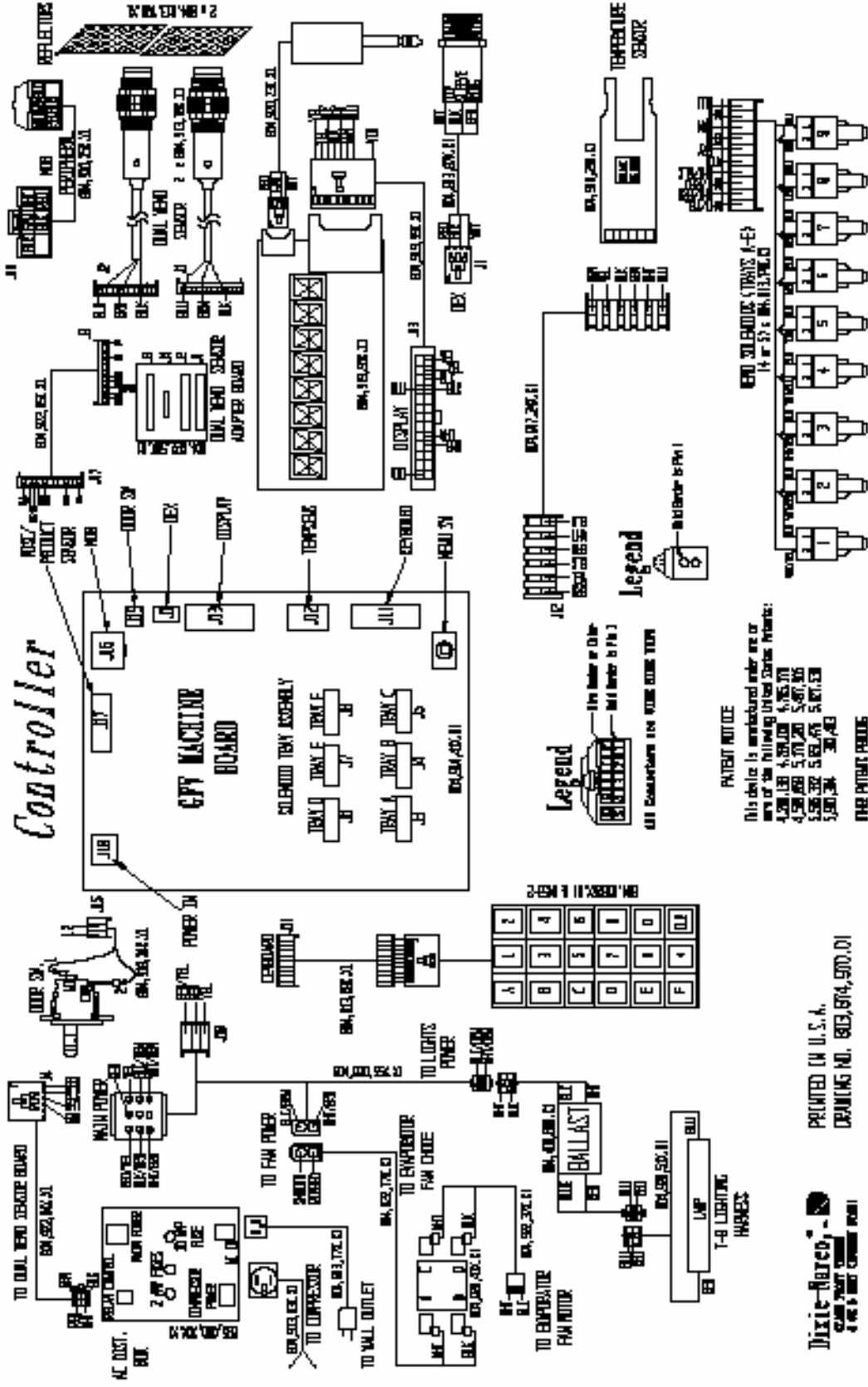

DN35## VENDER NON ENERGY STAR (Beverage Max Diagram 6 Column)

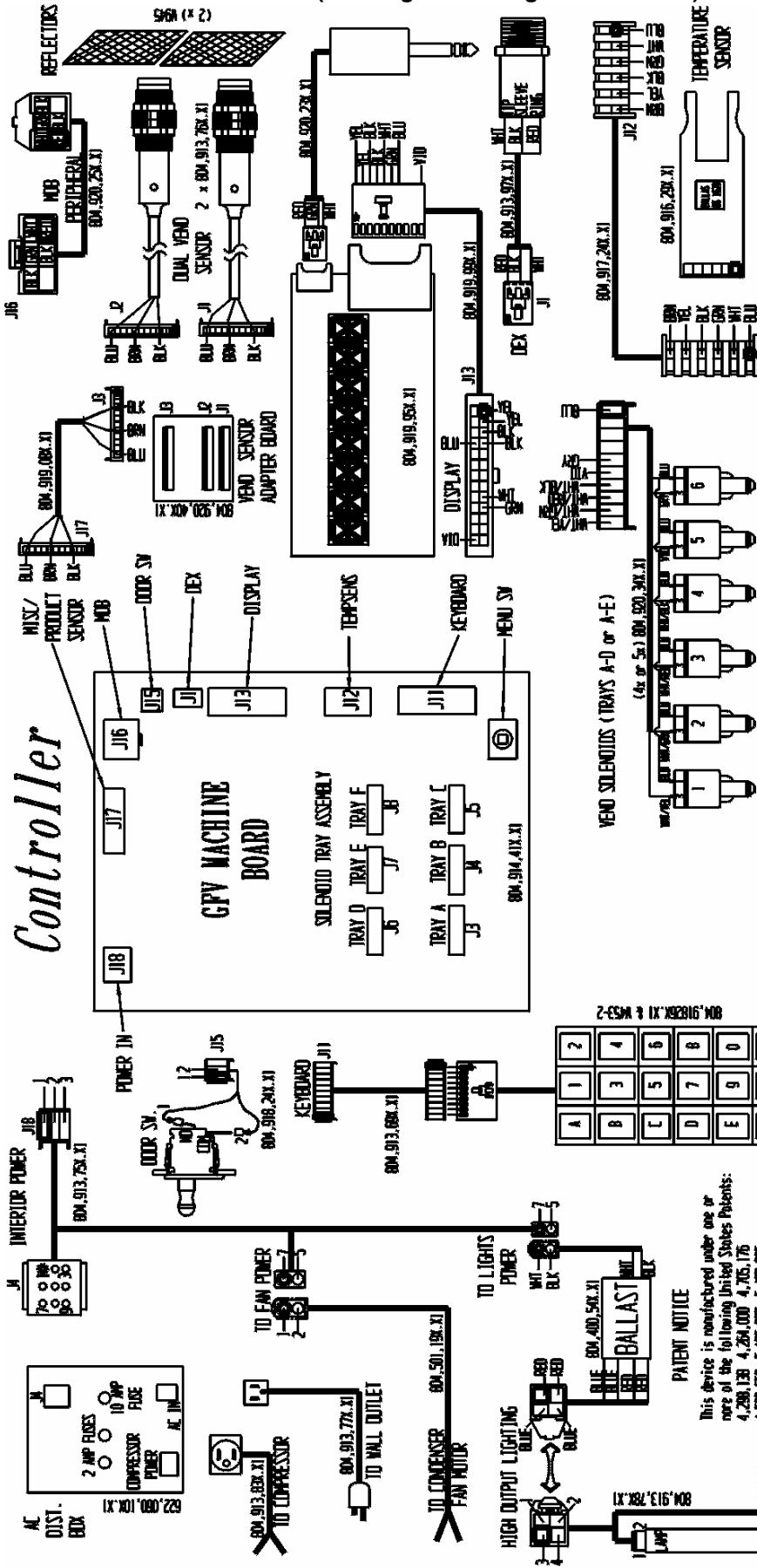

Controller

PATENT NOTICE
This device is manufactured under one or more of the following United States Patents:
4,288,128 4,264,000 4,705,176
4,509,658 5,176,287 5,497,965
5,505,332 5,651,476 5,907,538
5,957,364 362,463

Dixie-Narco, Inc.
CLASS PATENT 10000
4 TRAY

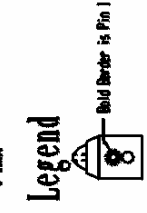

All Connectors are **VITEC 5198 V18R**

DN35## ENERGY STAR VENDER
(Beverage Max Diagram 6 Column)

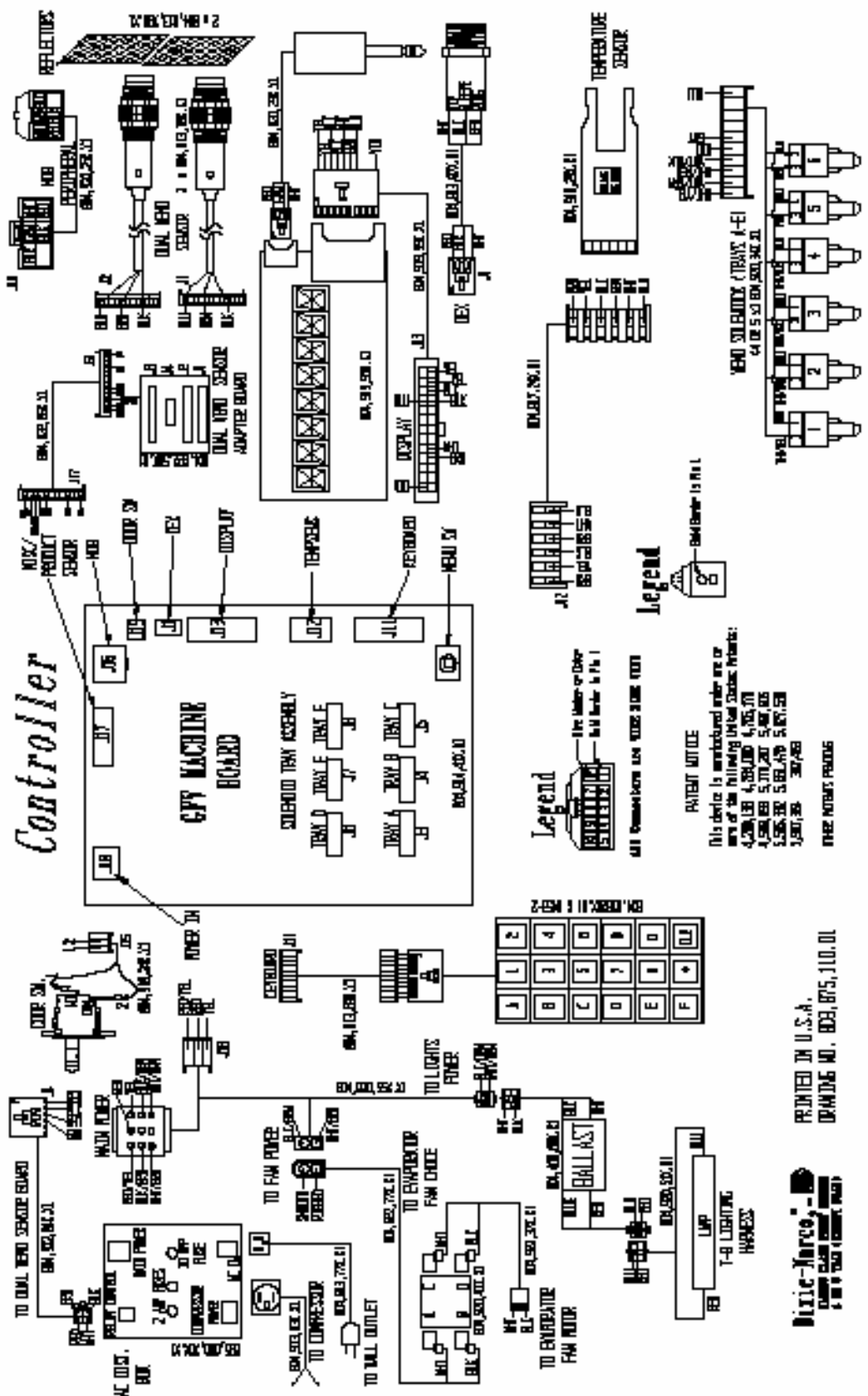

Printed in U.S.A.
 Dixie-Marco
 1-800-368-3333
 1-800-368-3333
 1-800-368-3333

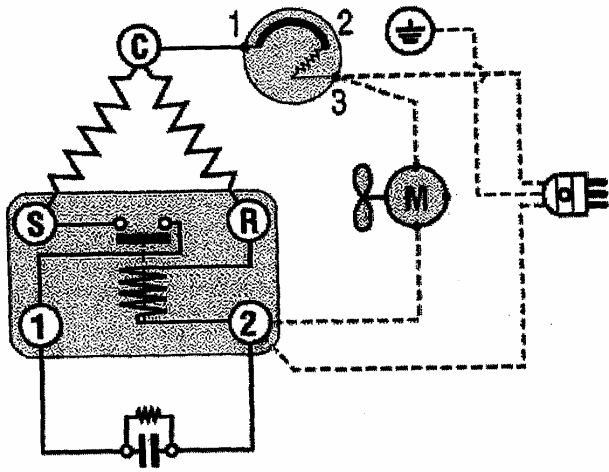

Symbol	Description
	Current Start Relay with Capacitor Connections
	Start Capacitor
	Overload Protector
	Fan
	Single Phase Motor
	Earth Connection
	Single Phase Supply
	Common
	Run
	Start
	Factory Made Connections
	Connections to be made

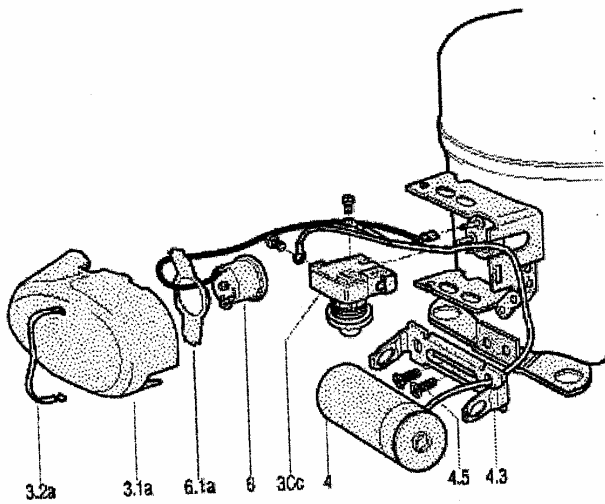

Ref	Symbol	Description
3Cc		Current Start Relay with Capacitor Connections
3.1a		Cover
3.2a		Cover Spring
4		Start Capacitor
4.3		Capacitor Clamp
4.4		Capacitor fixing bracket
4.5		M5 Self-tapping Screw
6		Overload Protector
6.1a		Overload Spring

DN55##/35## Compressor Wiring Diagram

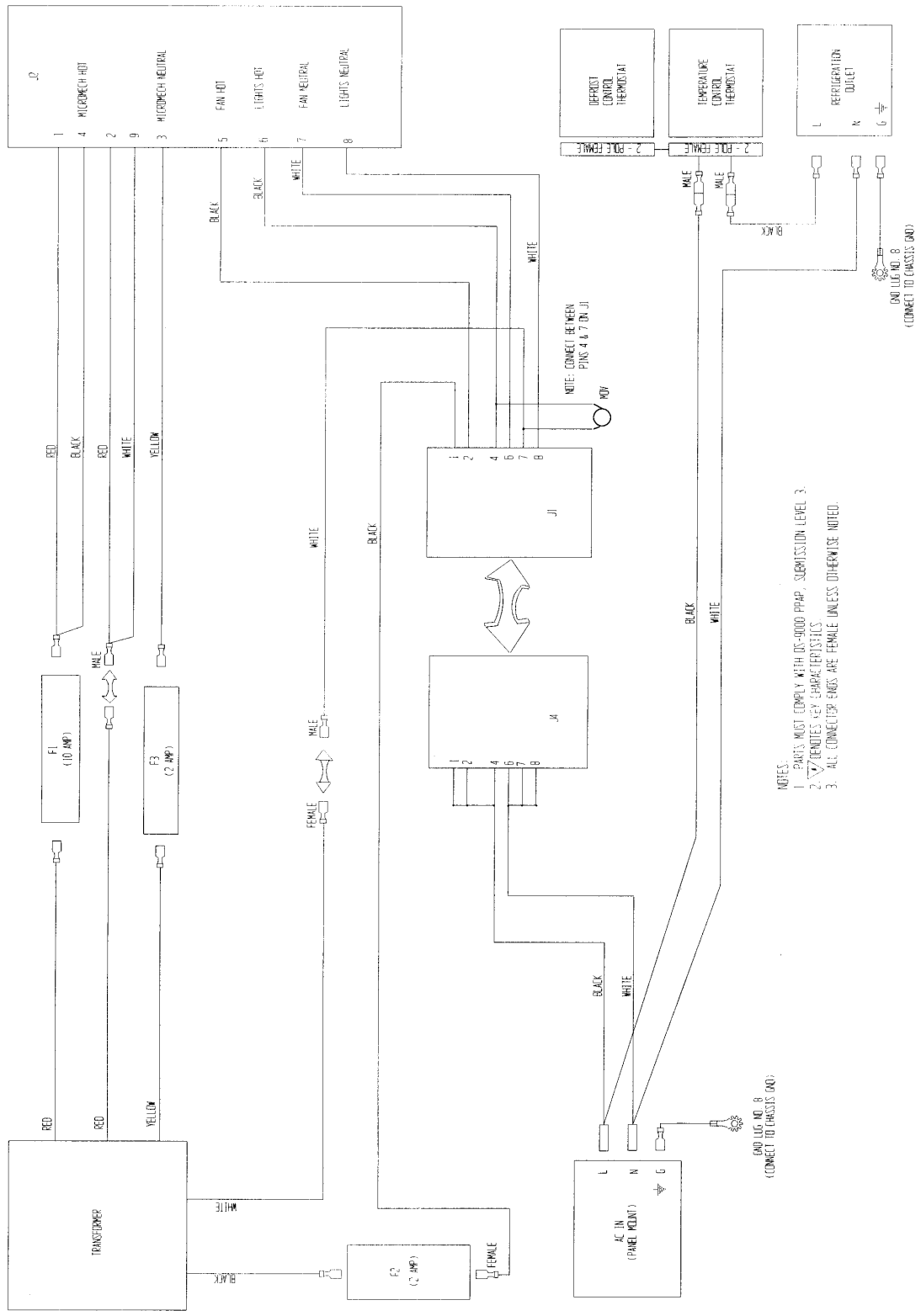

DN55##/DN2145
 AC DISTRIBUTION BOX SCHEMATIC DOMESTIC
 NON ENERGY STAR
 FIGURE 3

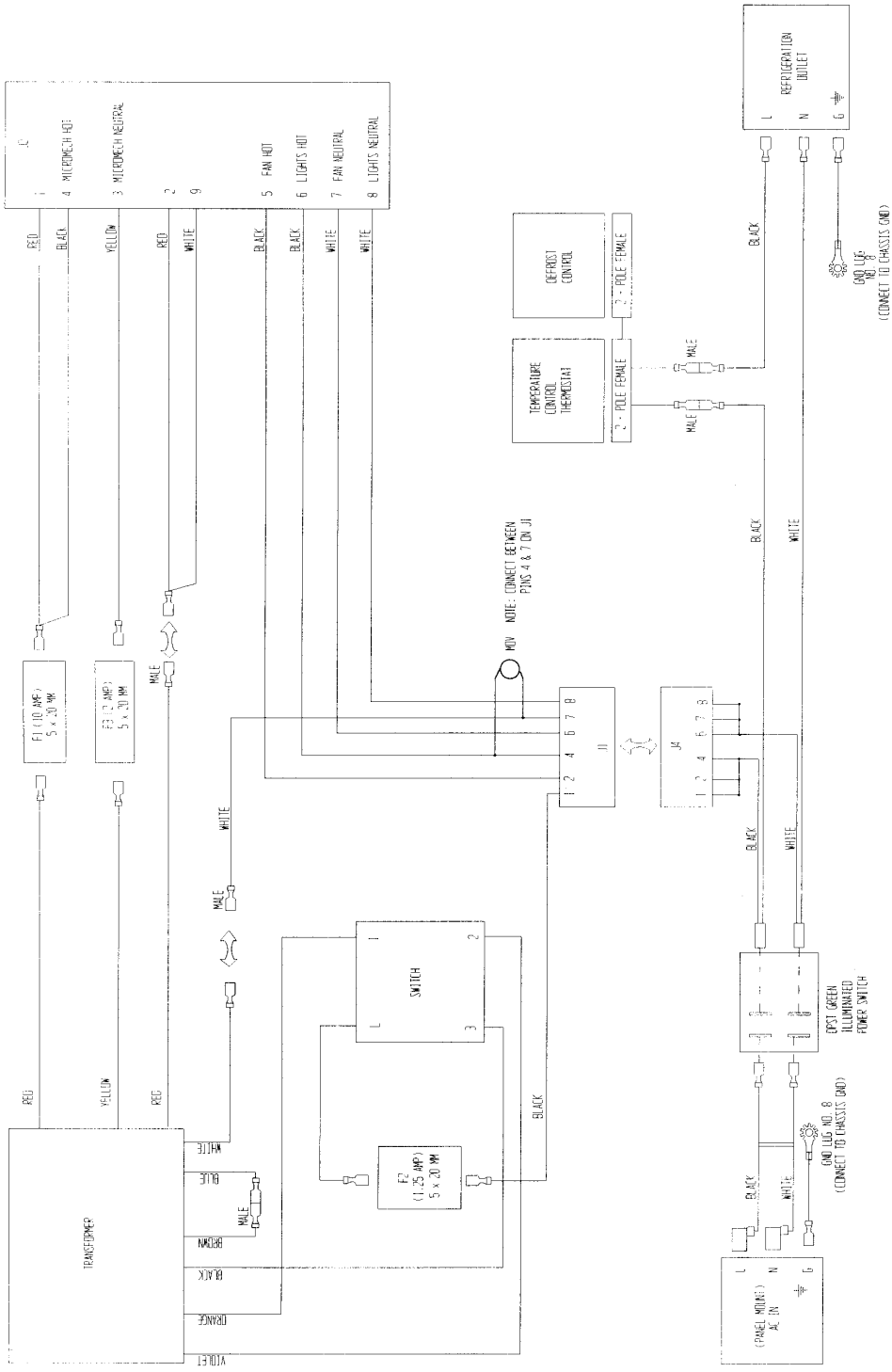

DN55##/2145
 AC DISTRIBUTION BOX SCHEMATIC – EXPORT
 FIGURE 4

NOTES:
 1. ALL CONNECTOR ENDS ARE FEMALE UNLESS OTHERWISE NOTED.

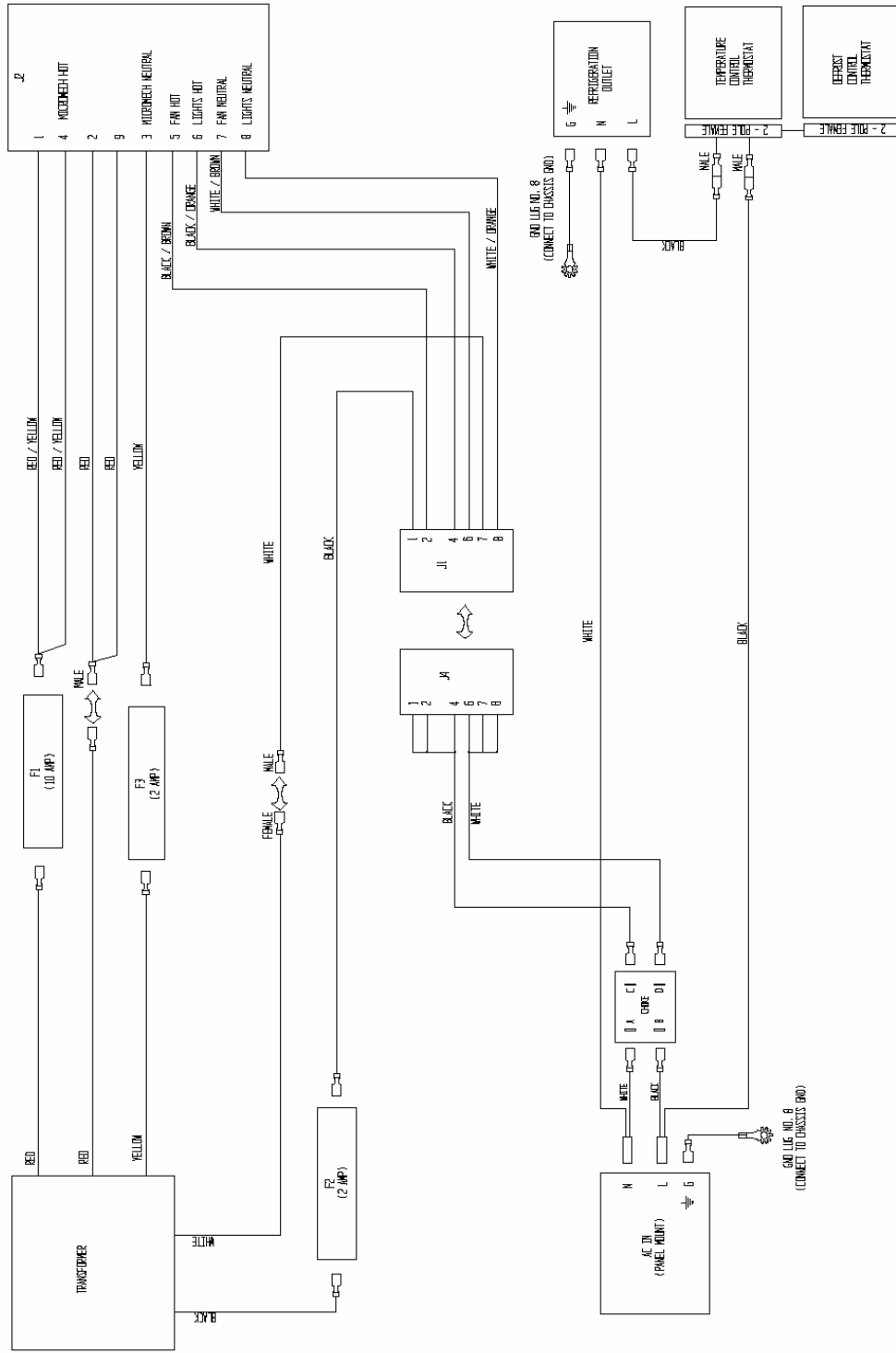

DN35##
 AC DISTRIBUTION BOX SCHEMATIC – DOMESTIC
 NON ENERGY STAR
 FIGURE 5

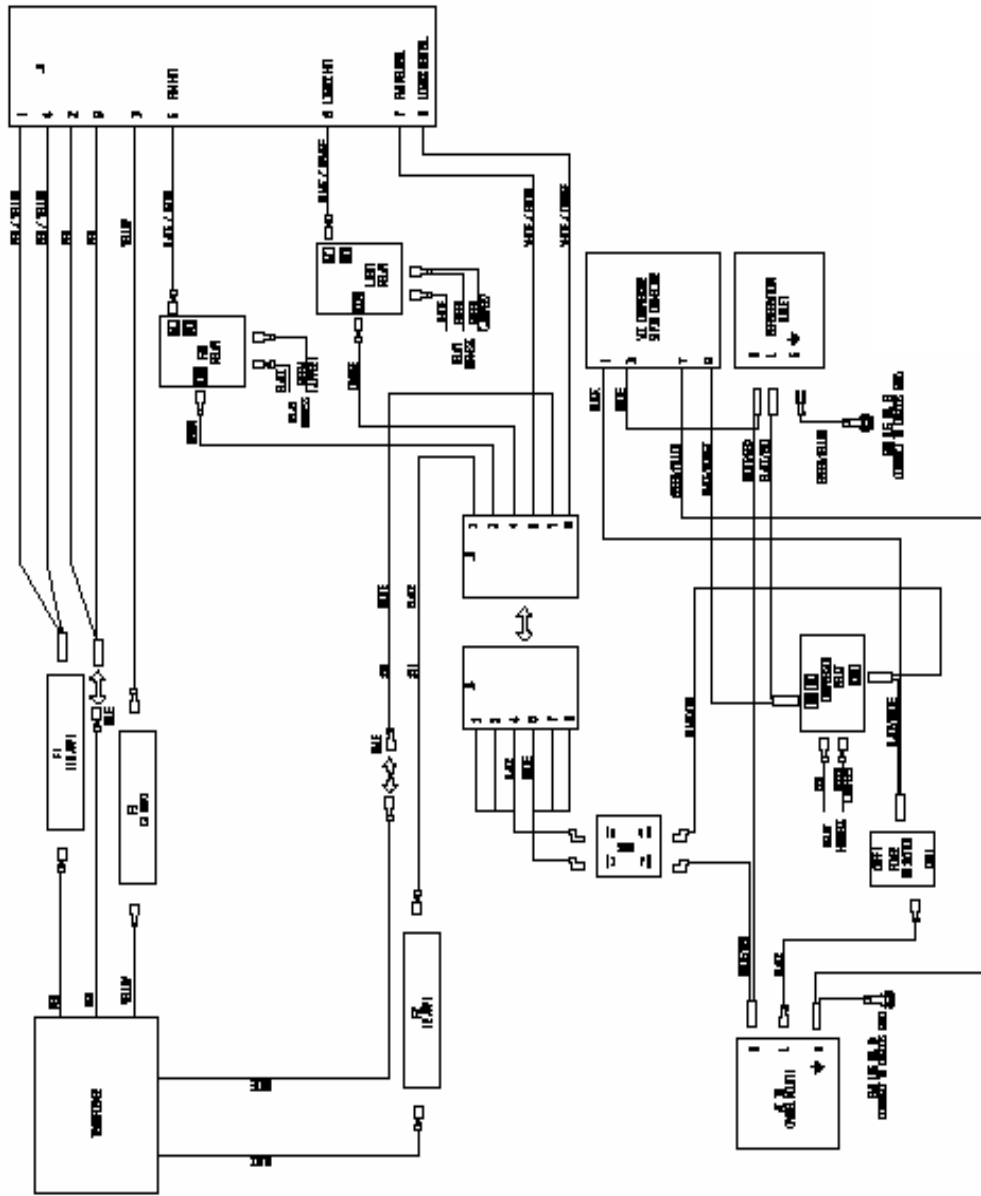

DN55##/35##
 AC DISTRIBUTION BOX SCHEMATIC – DOMESTIC
 ENERGY STAR
 FIGURE 6

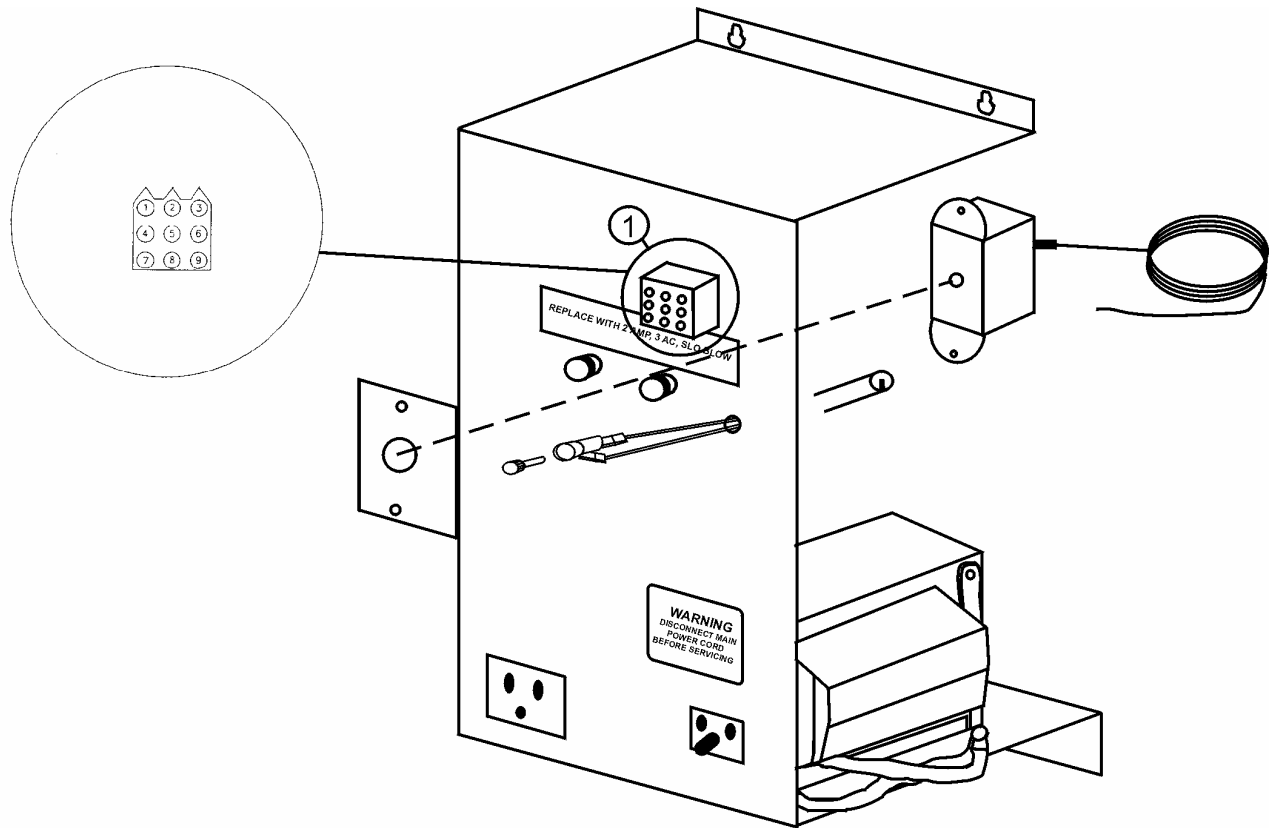

AC VOLTAGES			
Between Pins		Domestic Reading	Export Reading
1	2	24 VAC	24 VAC
1	3	12 VAC	12 VAC
2	3	12 VAC	12 VAC
4	9	24 VAC	24 VAC
5	7	115 VAC	220 VAC
6	8	115 VAC	220 VAC

AC DISTRIBUTION BOX, J2 VOLTAGES – ITEM 1

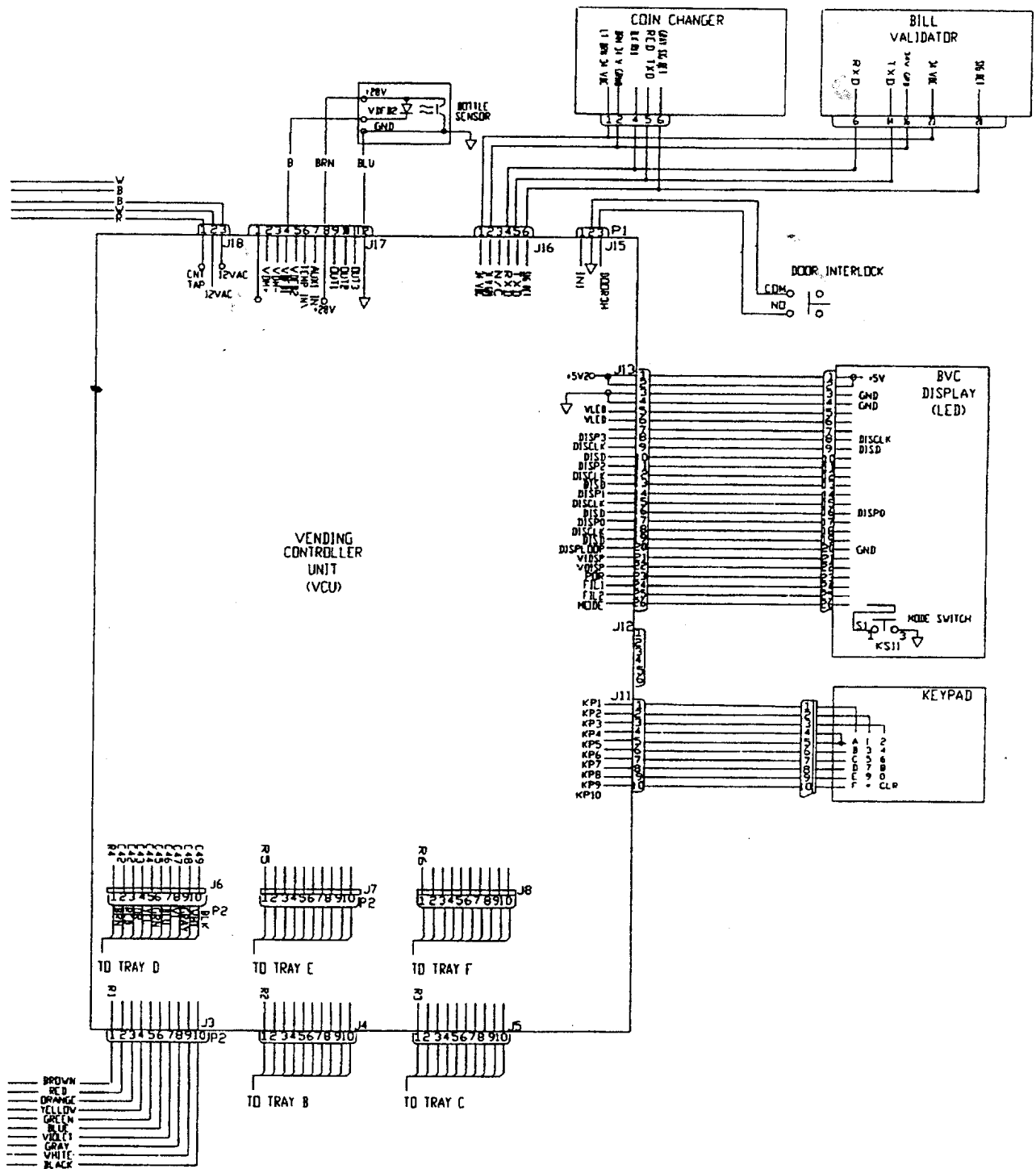

ECC SYSTEM SCHEMATIC (RIGHT SIDE; MDB)
SAMPLE

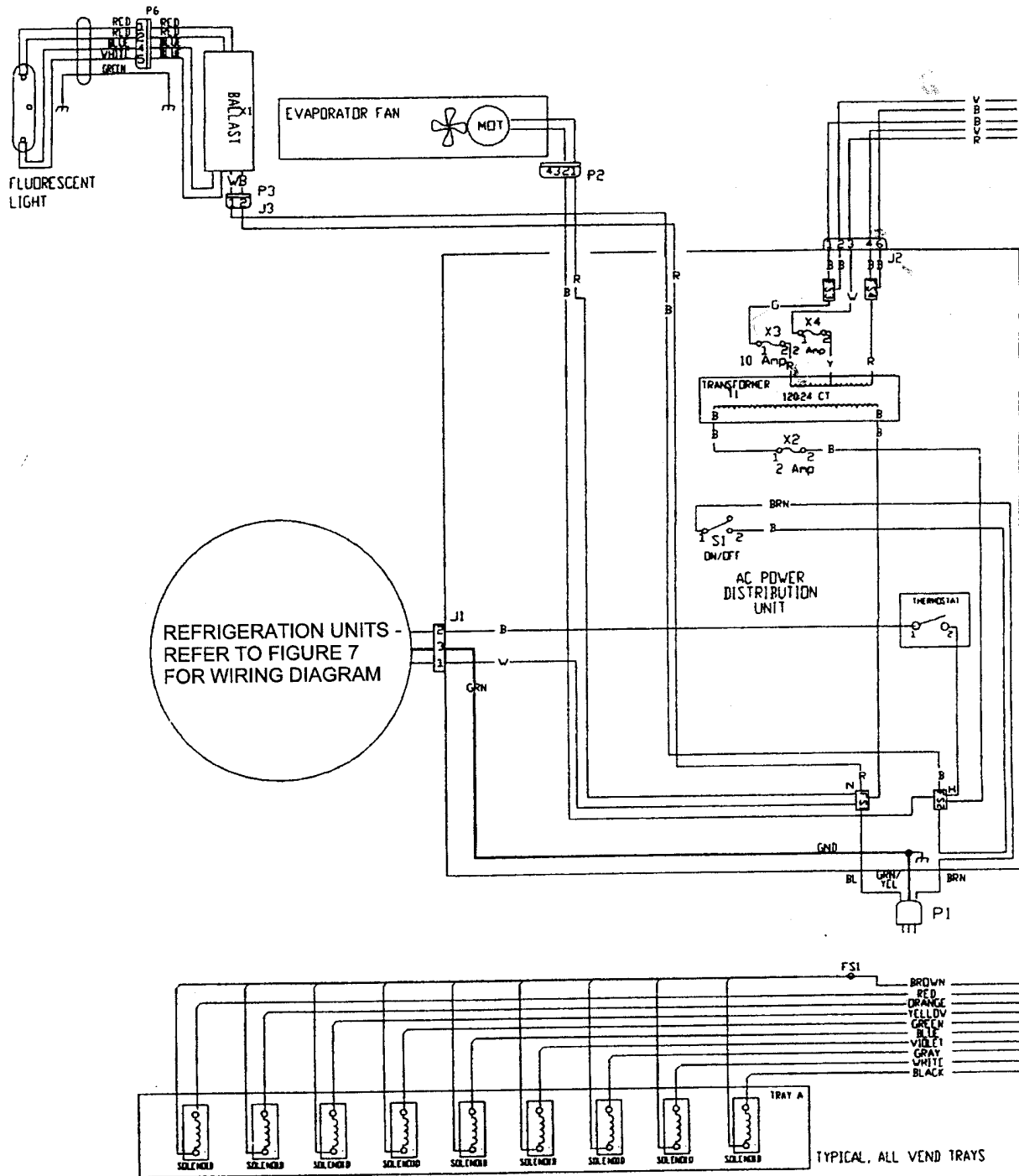

ECC SYSTEM SCHEMATIC (LEFT SIDE)
SAMPLE

ITEM	PART NUMBER	DESCRIPTION	QTY.
1	622.000.500.43	BOX, AC DISTRIBUTION ASSY 2145	1
2	622.000.400.43	ASSY, AC DISTRIBUTION BOX SIDE PANEL 2145	1
3	622.000.124.41	BRACKET, DUAL TEMPERATURE CONTROL	1
4	804.015.544.41	TEMPERATURE CONTROL LEAF	1
5	802.000.604.41	TEMPERATURE CONTROL LE	1
6	802.000.604.41	TEMPERATURE CONTROL LE	1
7	804.004.204.41	WIRING, DUAL TEMPERAT	1
8	800	DUCT, AC PANEL MOUNT	1
9	804.015.624.41	PLUG, DN 2145 POWER INLET	1
10	804.015.724.41	WIRING, AC BOX POWER DISTRIBUTION 2145	1
11	W60	FUSE HOLDER, PANEL MOUNTED (3 PCS EACH)	3
12	W60	FUSE, 2 AMP, 250V STD RLD	2
13	W60	FUSE, 10 AMP 37V	1
14	900.301.504.41	SCREW, P-32 X 3/8 PHIL PAN TYPE 1	8
15	900.000.504.41	WAL. TAPS 6-32	4
16	803.007.204.41	LABEL, TEMPERATURE CONTROL	1
17	803.007.224.41	LABEL, AC DISTRIBUTION BOX POWER DISCONNECT	1
18	803.007.274.41	LABEL, AC DISTRIBUTION BOX FUSES	1
19	900.007.614.41	LABEL, GROUND	3
20	900.007.614.41	CLIP, TEMPERATURE CONTROL	1
21	800.003.204.41	SCREW, 10-32 X .5 PHIL PAN	2

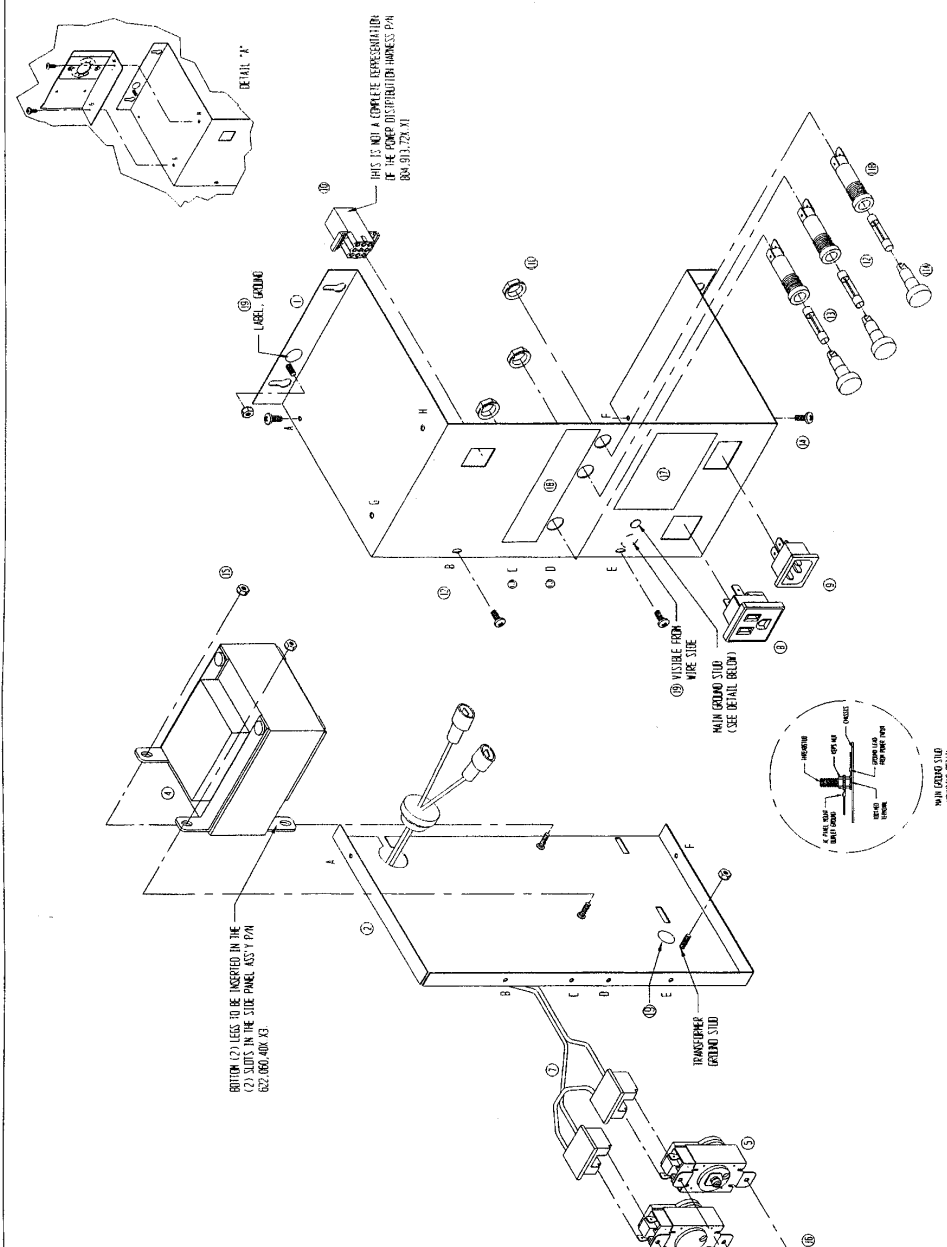

NOTES:
 1. PARTS MUST COMPLY WITH BS-5000 PPM.
 2. DIMENSIONS ARE APPROXIMATIVE.

THE END OF THE CAPTURED WIRE ATTACHED TO THE TEMPERATURE CONTROL LEAF AND THE END OF THE TEMPERATURE CONTROL CLIP WHICH IS LOCATED IN THE EMERGENCY COIL.

FOR MOUNTING SEE DETAIL 'A'

ASSY AC BOX DOMESTIC

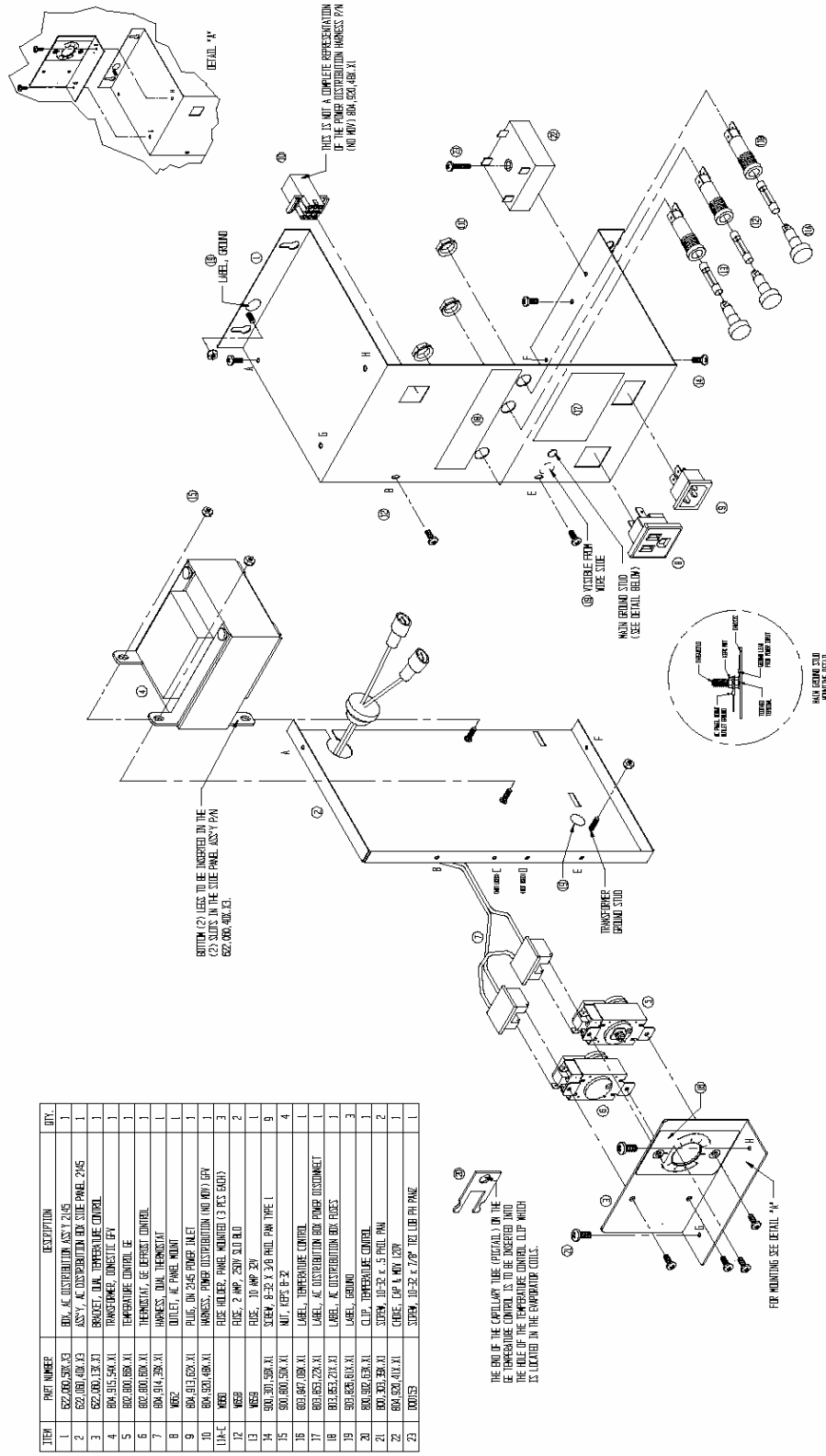

ITEM	PART NUMBER	DESCRIPTION	QTY.
1	622 000 200-33	BOX, AC DISTRIBUTION ASSY 2/5	1
2	622 000 400-33	ASSY, AC DISTRIBUTION BOX SIDE PANEL 2/5	1
3	622 000 100-31	BRACKET, ALUM. TEMPERATURE CONTROL	1
4	624 515 504-X1	TRANSFORMER, DOMESTIC 1/4	1
5	622 000 600-X1	TEMPERATURE CONTROL GE	1
6	622 000 600-X1	TEMPERATURE CONTROL GE	1
7	624 314 200-X1	HORNLESS, TUNA, THERMOSTAT	1
8	WSP	OUTLET, AC PANEL MOUNT	1
9	624 313 620-X1	PLUS, ON 2/4S PUMP INLET	1
10	624 301 400-X1	HORNLESS, PUMP DISTRIBUTION AND INLET	1
11	WSP	RODS, 2 AMP, 200V 3/10 BLD	2
12	WSP	RODS, 10 AMP 3/7	1
13	WSP	RODS, 8-20 X 3/8 HILL P/W TYPE 1	9
14	622 000 100-31	WSP, KEYS 8-2	4
15	622 000 100-X1	LABEL, TEMPERATURE CONTROL	1
16	622 000 100-X1	LABEL, AC DISTRIBUTION BOX PUMP DISCONNECT	1
17	622 000 100-X1	LABEL, AC DISTRIBUTION BOX PUMP DISCONNECT	1
18	622 000 100-X1	LABEL, AC DISTRIBUTION BOX PUMP DISCONNECT	1
19	622 000 100-X1	LABEL, GROUND	3
20	622 000 100-X1	CLIP, TEMPERATURE CONTROL	1
21	624 301 400-X1	STUMP, 10-20 X 5 PHIL P/W	2
22	624 301 400-X1	COVER, 10-20 X 5 PHIL P/W	1
23	622 000 100-X1	STUMP, 10-20 X 5 PHIL P/W	1

ASSY AC BOX DOMESTIC
T8 Electronic

PARTS LIST

PARTS LIST AND DIAGRAMS	55 – 89
Machine Front View 1	56 – 57
Machine Front View 2	58 – 59
Cabinet Detail.....	60 – 61
Lighting/Evaporator Fan	62 - 63
Service Door 1	64 – 65
Service Door 2.....	66 – 67
Service Door 3.....	68 – 69
Tall Tray Detail	70 – 71
Tall Gate Spacers	72
AC Distribution Box, Domestic.....	73 – 74
AC Distribution Box, Export	75 – 76
Refrigeration Unit DN59##/39## Fin & Tube Condenser.....	77 - 78
Refrigeration Unit DN59##/39## Fin & Tube Condenser.....	79 – 80
Electronics	81
Harnesses.....	82 – 83
Labels / Decals / Misc.	84
Screws & Nuts.....	85 – 86
Washers, Bolts, & Misc. Hardware	87 – 89

MACHINE FRONT VIEW 1

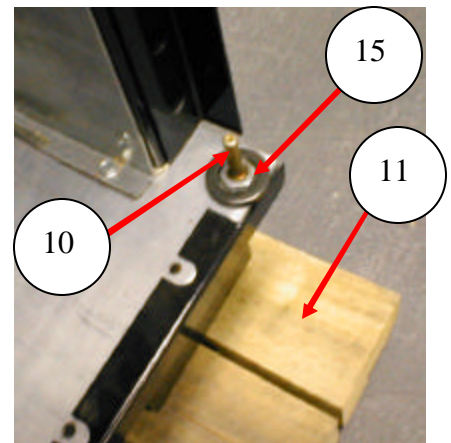
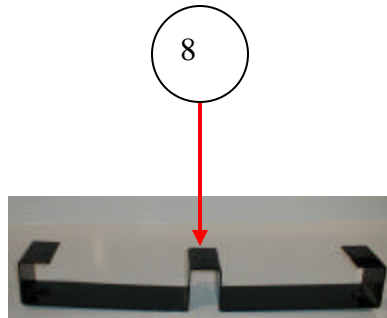
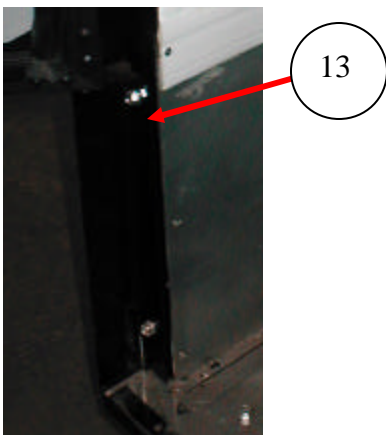
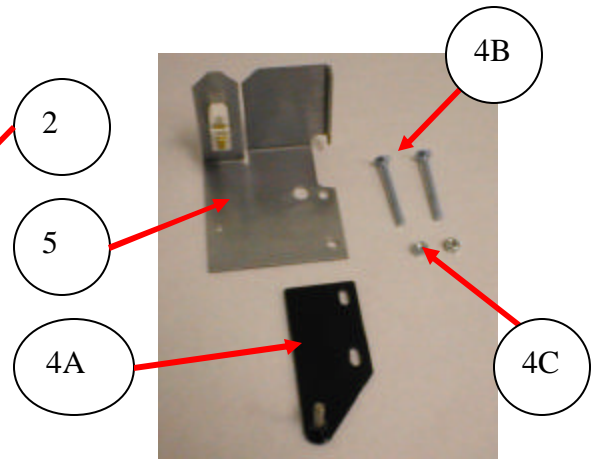
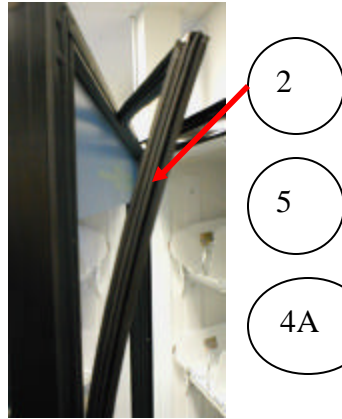
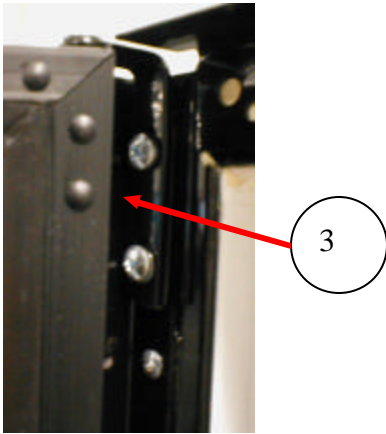
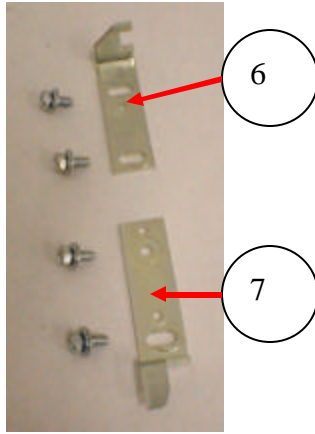
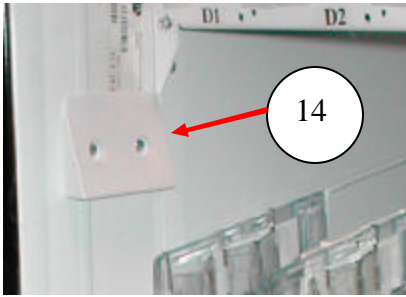

MACHINE FRONT VIEW 1

ITEM	PART DESCRIPTION	
1	DN55## Door Assembly, Glass (0001-8072 & higher)	800,101,89x.x1
	DN55###/54##Door Assembly, Glass Special 3 Pane (0001-8072 & higher)	800,102,11x.x1
	DN2145 Door Assembly, Glass (prior to 0001-8072) was W307	800,101,86x.x1
	DN35## Door Assembly, Glass (0001-8072 & higher)	800,102,18x.x1
2	DN55##/54## Gasket (0001-8072 & higher)	800,102,03x.x1
	DN55##/54##/2145 Gasket (0001-8014 to 0001-8072)	801,814,02x.x1
	DN2145 Gasket (prior to 0001-8014) was W058	obsolete
	DN35## Gasket	801,817,50x.x1
3	Top Hinge Glass Door (0001-8072 & higher)	801,305,70x.x1
	Pin, Pivot Top Glass Door (0001-8072 & higher) was 800,303,41x.x1	800,304,14x.x1
	DN2145 Top Hinge Glass Door (prior to 0001-8072*)	W327
4A	Top Hinge Service Door (All) was W334	801,307,94x.x1
4B	Carriage Bolt, 1/4 –20 X 2.5" was W766, was 900,202,20x.x1	800,202,49x.x1
4C	Hex Nut, 1/4-20 was 900,800,67x.x1	800,801,57x.x1
4D	Strike Plate, Service Door	626,030,34x.x3
5	Service Door Stop	627,050,42x.x3
6	Latch, 3-Point Lock	801,305,58x.x1
7	Strike, Door Lock, 3-Point	W296
8	DN55##/54##/35## Leg Assembly, Steel, Formed (0001-8072 & higher)	801,305,65x.x1
	DN2145 Leg Assembly, Steel, Formed (prior to 0001-8072) was W025-1	801,305,66x.x1
9	Leg Leveler, 5/8 – 11 x 2 1/16" (0001-8072 & higher) was 900,502,49x.x1	800,503,79x.x1
	Leg Leveler, ½ - 20, 2.88LG (prior to 0001-8072) was 900,502,95x.x1	800,503,79x.x1
10	Bottom Hinge, Service Door was 800,503,33x.x1	800,503,76x.x1
11	Shipping Boards, 34"	805,410,94x.x1
12	DN55##/54##/2145 Bottom Skirt	627,020,19x.x3
	DN35## Bottom Skirt	635,020,11x.x3
13	Bottom hinge Glass Door	W326
14	Deflector, Plastic Wedge was W363	801,811,07x.x1
15	Reflective Tape, 3" Square	W945
16	DN2145 only – Service Area Liner Shim, Glass Door 53" X 1 37/64" was W008	622,030,09x.x3
Part numbers & descriptions are subject to change with out notice. NA = Not applicable TBD = To be determined RB = Replaced by		

MACHINE FRONT VIEW 2



6
17

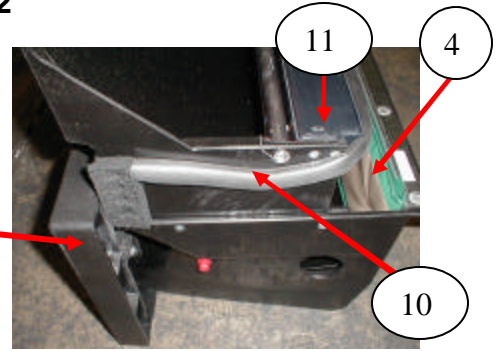

3



13

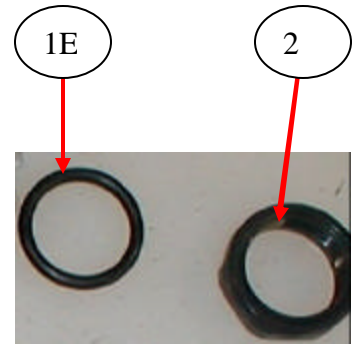

1E

2

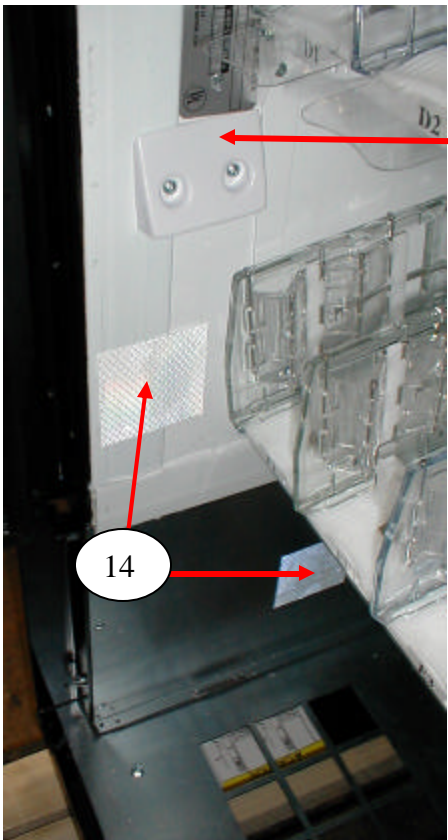

7

14

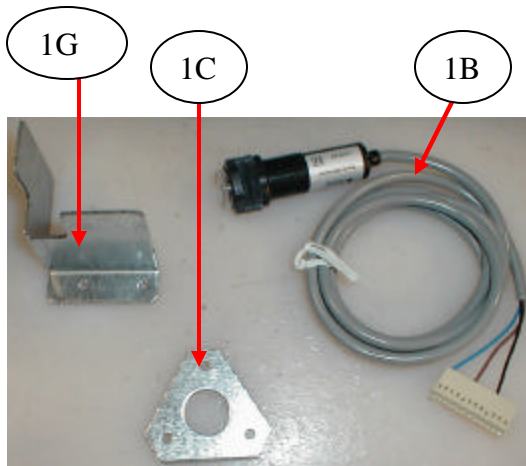

1G

1C

1B

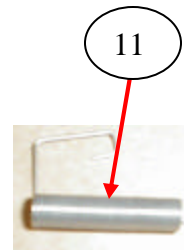

11

MACHINE FRONT VIEW 2

ITEM	PART DESCRIPTION	
1A	IR Vend Sensor Kit with Discs (available 2006 & up)	627,022,10x.x4
1B	Assembly, Product Sensor with Harness (Dual Sensor 8105 & higher) was 804,913,76x.x1	804,924,07x.x1
1C	Sensor Mounting – Directional Discs (2 needed, available 2006 & up)	804,801,08x.x1
	Sensor Mounting Plate – rectangular was 622,060,14x.x3	804,801,08x.x1
	Sensor Mounting Plate (2 nd Sensor – 0001-8072 & higher)	627,050,12x.x3
	Sensor Mounting Plate (prior to 0001-8072)	622,050,90x.x3
1D	Dual Vend Sensor Adapter Board Energy Star only	804,922,56x.x1
	Dual Vend Sensor Adapter Board Non Energy Star only	804,920,40x.x1
1E	Vend Sensor “O” Ring	900,701,27x.x1
1F	Phil Pan Screw 10-32x1/2 was 800,303,39x.x1	800,304,13x.x1
1G	Vend Sensor Protector Bracket	627,050,17x.x3
2	Nut, Optical Sensor Assembly	W979-1
3A	Bottom Hinge, Glass Door	W326
3B	Bottom Hinge Shim, Glass Door	635,050,22x.x3
4	Assembly Pad, Recovery Unit (removed in 2004)	805,202,36x.x1
5	Door Assembly, Recovery Unit	801,810,97x.x1
6A	DN55##/54## Assembly, Recovery Unit, Tall Anti Pilfer (0001-8072 & higher)	801,816,27x.x1
6B	DN2145 Assembly, Recovery Unit, Tall (prior to 0001-8072) was 801,810,91x.x1	RB 6A
6C	DN35## Assembly, Recovery Unit with Anti Pilfer Kit	801,817,42x.x1
7	Deflector, Bottle Drop Plastic Wedge	801,811,07x.x1
8	DN2145 Door Stiffener Angle, Recovery Unit (prior to 079-8019)	622,070,05x.x3
9	DN2145 Magnet Recovery Unit (prior to 079-8019)	801,518,40x.x1
10	Gasket (Seal)	902,100,32x.x1
11A	Spring Delivery Door DN55##/2145 (079-8019 and higher)	801,701,09x.x1
11B	Spring Delivery Door DN35##	801,701,18x.x1
12	Evaporator Duct Air Deflector	W448
13	Suction Tube Guard was W270	627,050,46x.x3
14	Reflective Tape 3” Square	W945
15A	DN55##/54## Bottom Skirt	627,020,19x.x3
15B	DN2145 Bottom Skirt	622,070,09x.x3
15C	DN35## Bottom Skirt	635,020,11x.x3
16	Security Flap Rod (used with Kit D001)	801,904,26x.x1
17A	DN55##/54## Anti-Pilfer Retrofit Kit Assembly	627,011,10x.x3
17B	DN35## Anti-Pilfer Retrofit Kit Assembly	635,010,10x.x4

Part numbers & descriptions are subject to change with out notice.
 NA = Not applicable TBD = To be determined RB = Replaced by

**Note: Pike door assembly began 8/31/98 (8014CW)
 Includes 70 pieces week of 8/17/98 (8014CW) and 20 pieces (8011CW) – 006, 021, 023, 024, 025, 045, 046,
 048, 049, 050, 052, 053, 054, 056, 057, 058, 059.
 Commercial door assembly (W307) was used prior to Pike door assembly.*

CABINET DETAIL

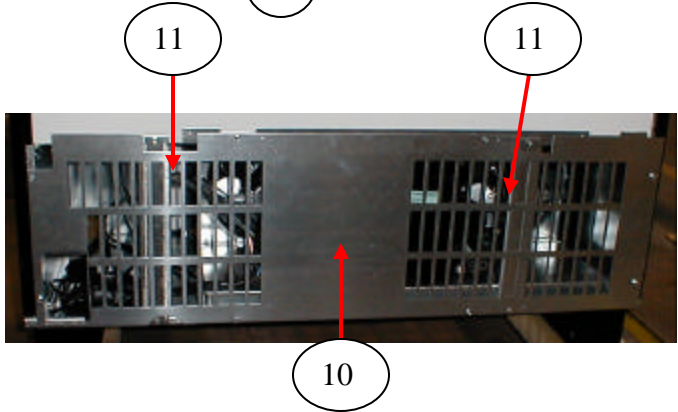
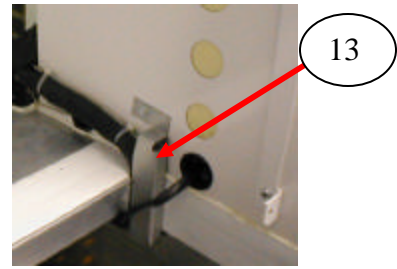
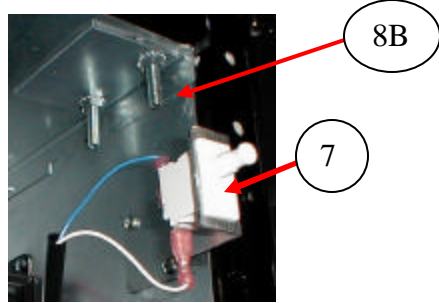
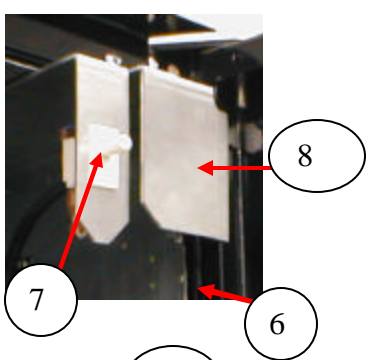
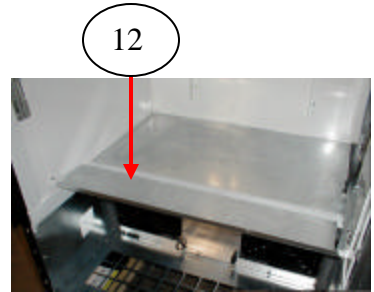
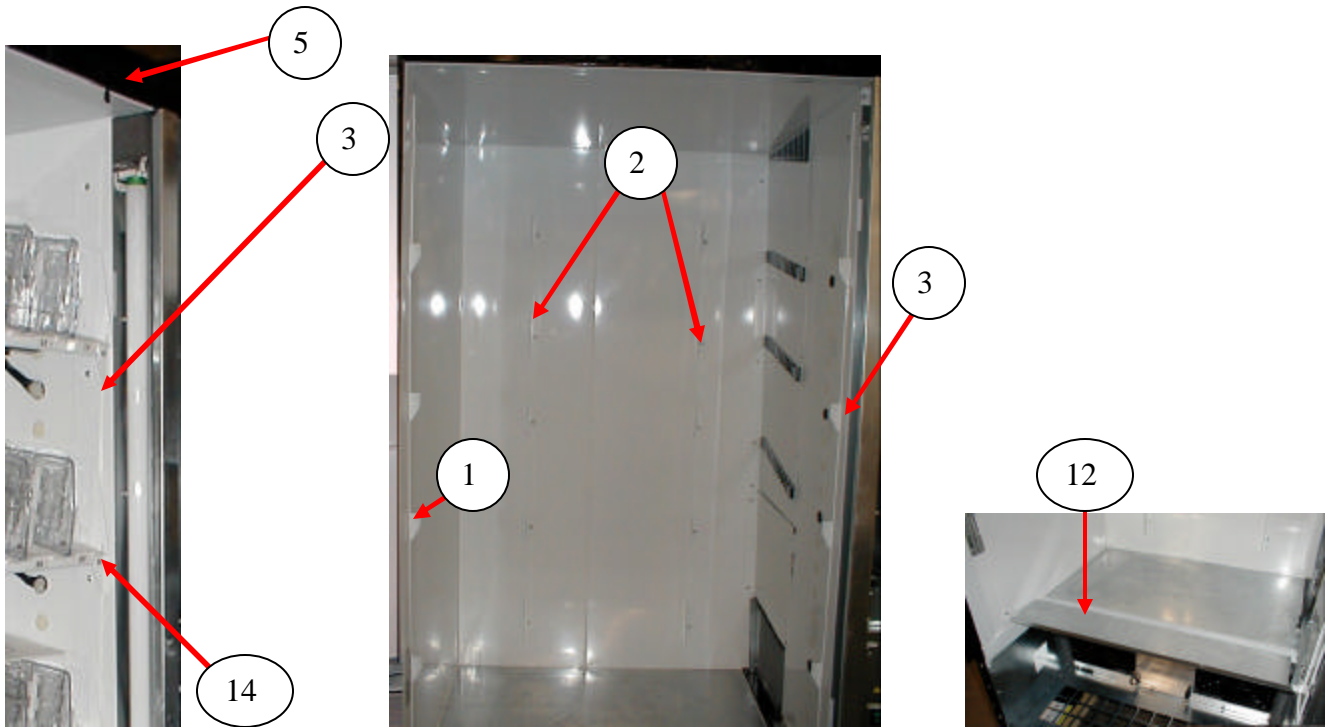

CABINET DETAIL

ITEM	PART DESCRIPTION	
1	Left Tray Mounting Bracket, Domestic DN5591/3591	627,070,21x.x3
	Left Tray Mounting Bracket, Domestic DN5592/3592 was 627,070,08x.x3	627,070,28x.x3
	Left Tray Mounting Bracket, Domestic DN5593 was 627,070,12x.x3	627,070,34x.x3
	Left Tray Mounting Bracket, Domestic DN5594/3594	627,070,25x.x3
	Left Tray Mounting Bracket, Domestic DN2145	622,070,02x.x3
	Left Tray Mounting Bracket, Export DN2145	622,050,35x.x3
	Left Tray Mounting Bracket, Mexico 600ml DN2145 (4 shelf)	622,050,36x.x3
2	Rear Tray Support Bracket, Domestic DN5591/3591	627,070,23x.x3
	Rear Tray Support Bracket, Domestic DN5592/3592 was 627,070,07x.x3	627,070,31x.x3
	Rear Tray Support Bracket, Domestic DN5593 was 627,070,11x.x3	627,070,36x.x3
	Rear Tray Support Bracket, Domestic DN5594/3594	627,070,27x.x3
	Rear Tray Support Bracket, Domestic DN2145	D042
	Rear Tray Support Bracket, Export DN2145	622,050,33x.x3
	Rear Tray Support Bracket, Mexico 600ml DN2145 (4 shelf)	622,050,38x.x3
3	Right Tray Mounting Bracket, Domestic DN5591/3591	627,070,22x.x3
	Right Tray Mounting Bracket, Domestic DN5592/3592 was 627,070,09x.x3	627,070,29x.x3
	Right Tray Mounting Bracket, Domestic DN5593 was 627,070,13x.x3	627,070,35x.x3
	Right Tray Mounting Bracket, Domestic DN5594/3594	627,070,26x.x3
	Right Tray Mounting Bracket, Domestic 20 oz. DN2145	622,070,03x.x3
	Right Tray Mounting Bracket, Export DN2145	622,050,34x.x3
	Right Tray Mounting Bracket, Mexico 600 ml DN2145 (4 shelf)	622,050,37x.x3
4	DN55## /35## Security Angle Hinge, Left	627,020,11x.x3
	DN2145 Security Angle Hinge, Left	622,060,06x.x3
5	DN55## Security Angle Top	627,020,13x.x3
	DN2145 Security Angle Top	622,050,04x.x3
	DN35## Security Angle Top	635,020,06x.x3
6	Security Angle Right DN55##/35##	627,020,12x.x3
	Security Angle, Right DN2145	622,060,07x.x3
7	Switch Door	804,100,77x.x1
8A	Service Door Stop & Door Switch Bracket	622,060,05x.x3
8B	Door Switch Bracket	RB 8A
9	Rear Plate	801,903,56x.x1
10A	Ingress Guard DN55##(Export not shown)	622,050,39x.x3
10B	Ingress Guard DN35##	635,050,13x.x3
11	Brace, Rear Base Plate	622,020,08x.x3
12	DN55##/54##/2145 Bottom Tray Guard	627,071,10x.x3
	DN35## Bottom Tray Guard	635,070,60x.x3
13	Suction Tube Guard was W270	627,050,46x.x3
14	Screw, Tray Support #8-18X1/2 self drilling was 900,301,50x.x1	800,304,18x.x1

Part numbers & descriptions are subject to change with out notice.
 NA = Not applicable TBD = To be determined RB = Replaced by

LIGHTING / EVAPORATOR FAN

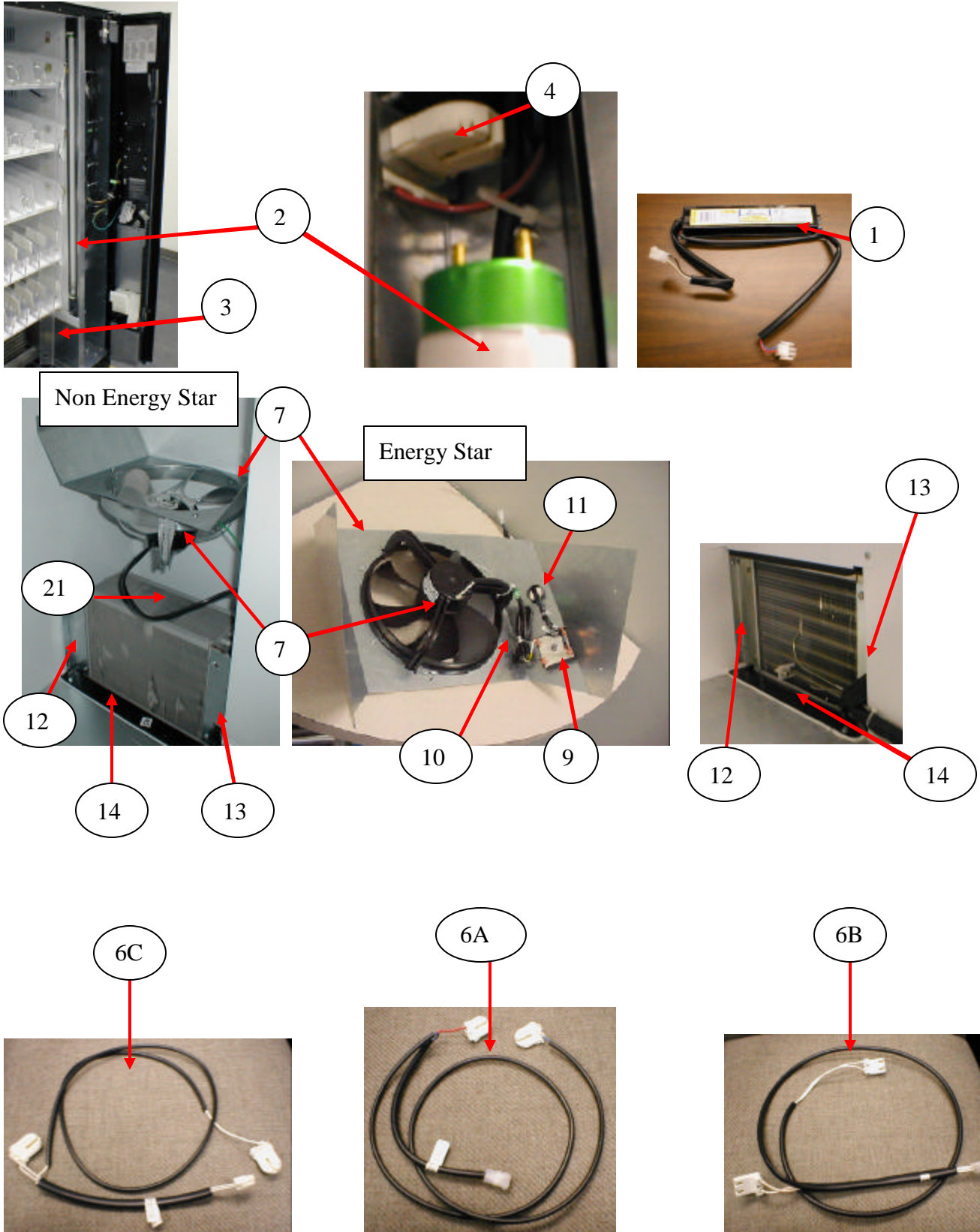

LIGHTING / EVAPORATOR FAN

ITEM	PART DESCRIPTION	
1	Assembly, Ballast 120V/60Hz Electronic (Sylvania) T8 Electronic (0304-8225 & up)	804,400,69x.x1
	Assembly, Ballast 120V/60Hz Electronic (Advance) T8 Electronic (0304-8225 & up)	804,400,68x.x1
	Assembly, Ballast 120V/60Hz Electronic T8 Magnetic Rapid Start (prior to 0304-8225)	804,400,54x.x1
	Assembly, Ballast 220-240V / 50 Hz Export HF-Basic II was 804,400,56x.x1	804,401,07x.x1
2	Lamp, Fluorescent T8 48" F32T8TL841 (0304-8225 & up)	804,700,65x.x1
	Lamp, Fluorescent 40W 48" (prior to 0304-8225)	W845
3A	Lens, Lamp Extrusion	801,904,15x.x1
3B	Lens, Lamp Assembly – W351	RB 3A
	Lens, Lamp Assembly – 801,903,91x.x1	RB 3A
4	Lamp Holder Assembly, T8 Electronic (includes base and harness) 110V (0304-8225 & up)	622,062,50x.x3
	Lamp Holder Assembly, T8 Magnetic 110V (prior to 0304-8225)	622,060,20x.x3
	Lamp Holder Assembly (includes base and harness) 220-240V	622,061,50x.x3
5	Lamp Holder Bracket, T8 Electronic (0304-8225 & up)	622,020,22x.x3
	Lamp Holder Bracket, T8 Magnetic (prior to 0304-8225)	
6A	Lighting Harness T8 Electronic (0304-8225 & up)	804,920,51x.x1
6B	Lighting Harness T8 Magnetic (prior to 0304-8225)	804,913,78x.x1
6C	Lighting Harness 220-240V	804,926,04x.x1
*7	Evaporator Fan Assembly (120V/60Hz, 9W) Energy Star New EBM 5 Blade Metal	647,052,10x.x3
*	Evaporator Fan Assembly (120V/60Hz, 9W) Energy Star Original ECM 7 Blade Plastic	627,052,40x.x3
	Evaporator Fan Assembly (120V/60Hz, 9W) Non Energy Star was W362	622,041,10x.x3
	Evaporator Fan Assembly (230V/50Hz, 9W) was W287	622,041,00x.x3
	Evaporator Fan Assembly (220V/50Hz, 9W)	622,043,00x.x3
**8	Evaporator Fan Motor, EBM 5 Blade Metal (120V/60Hz) Energy Star	804,501,48x.x1
**	Evaporator Fan Motor, 58mm ECM 7 Blade Plastic (120V/60Hz) Energy Star	804,501,28x.x1
	Evaporator Fan Motor (115V/60Hz) Non Energy Star was W369	804,501,09x.x1
	Evaporator Fan Motor (230V/50Hz, 9W)	W130
	Evaporator Fan Motor (220-230V/50Hz)	804,501,11x.x1
9	Choke (Energy Star Evaporator Assy)	804,920,41x.x1
10	Harness, Energy Star Evaporator Choke Extension	804,922,77x.x1
11	Harness, Energy Star Evaporator	804,922,37x.x1
12	Rear Evaporator Mounting Bracket	635,050,14x.x3
13	Notched Evaporator Mounting Bracket	635,050,15x.x3
14	Evaporator Drain Pan Assembly	622,041,20x.x3
15	Door Stiffener Angle, Recovery Flap	622,070,05x.x3
16	Vertical Edge Cover Strip	803,865,86x.x1
17	Top Edge Cover Strip	803,866,37x.x1
18	Evaporator Duct Air Deflector	W448
Part numbers & descriptions are subject to change with out notice. NA = Not applicable TBD = To be determined RB = Replaced by ** Important: An EBM Fan will not fit in the ECM Fan Housing Assembly. * The Evaporator Fan Assemblies are interchangeable in the vender.		

SERVICE DOOR 1

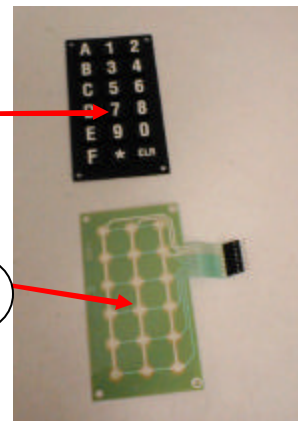
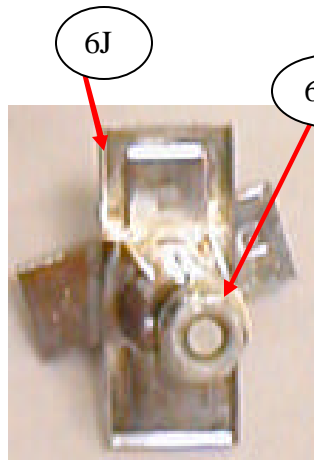
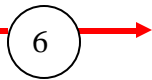
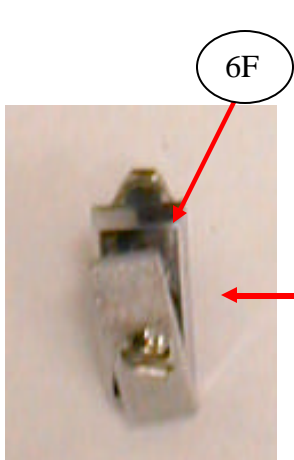
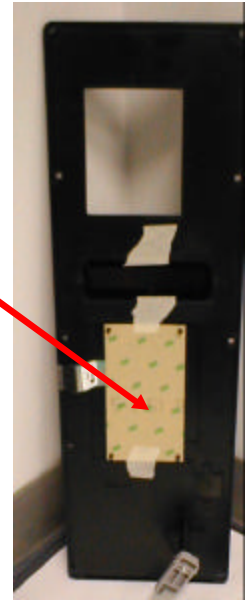
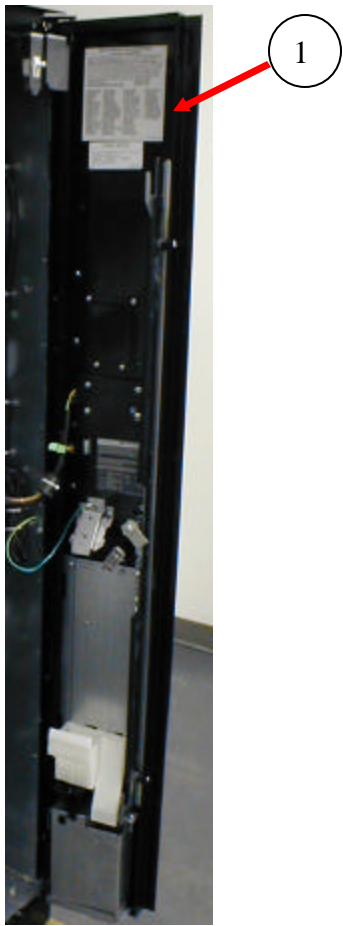

SERVICE DOOR 1

ITEM	PART DESCRIPTION	
1	Service Door Assembly, 3 Point Lock DN55###/54###/35## (8072 & higher)	627,051,50x.x3
	Service Door Assembly, Double Knock Out, 3 Point Lock DN55###/54###/35##	627,051,70x.x3
	Service Door Assembly, 3 Point Lock DN2145	622,050,50x.x3
	Service Door Assembly, Double Knock Out, 3 Point Lock DN2145	622,051,70x.x3
	Service Door Assembly, 3 Point Lock Japan Export	637,052,70x.x3
2	Label, Coin Return Service Door Bezel was W383	803,857,25x.x1
3	Label, Coin Insert Service Door Bezel Domestic	803,902,72x.x1
	Label, Coin Insert Service Door Bezel Export	803,902,74x.x1
4A	Carriage Bolt 10 – 24 X .82" was W718	800,202,51x.x1
4B	Hex Nut with washer 10 - 24 was W906	800,801,66x.x1
5A	Assembly, Coin Return Lever	800,502,98x.x1
5B	Coin Return Lever Limiter	801,305,22x.x1
6	T-Handle Assembly	801,518,06x.x1
6A	Nut, ½-20 Hex	801,518,02x.x1
6B	Washer, 1/2" Int. Tooth Lock	801,518,03x.x1
6C	90 Degree Locking Cam	801,518,04x.x1
6D	Pawl	801,518,05x.x1
6E	E-Ring, #31-30 was 801,507,34x.x1	901,503,07x.x1
6F	Lock Body, Flush Mount	801,507,98x.x1
6G	Hex Washer, #29-34	901,503,08x.x1
6H	Cross Pin, T-Handle	901,503,09x.x1
6I	T-Handle Spring	901,503,05x.x1
6J	T-Handle	801,505,73x.x1
7	Button Array Keypad, Rubber	W453-2
8	Keypad, Membrane Switch	804,918,26x.x1
9	Harness, Keypad (Controller to Keypad)	804,913,69x.x1
10	Bezel, IR Service Door DN55###/54###/35## (0001-8206 & up)	801,816,01x.x1
	Bezel, Service Door DN55###/54###/35## (0001-8072 to 0001-8206) was 801,810,52x.x1	801,816,01x.x1

Part numbers & descriptions are subject to change with out notice.
 NA = Not applicable TBD = To be determined RB = Replaced by

SERVICE DOOR 2

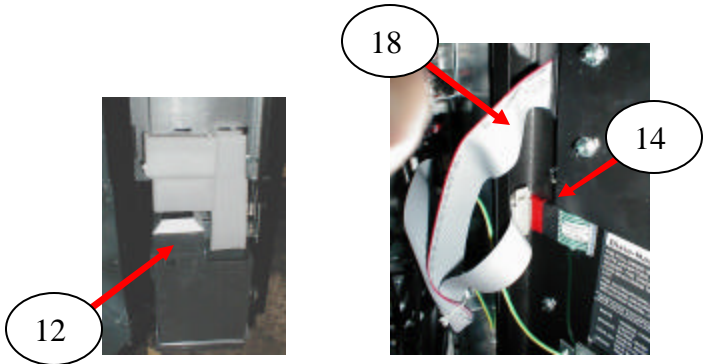
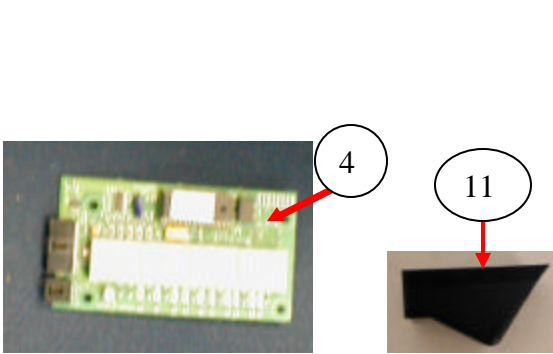
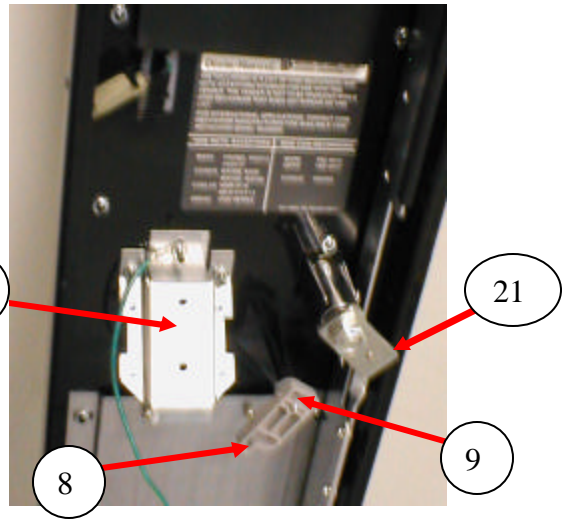
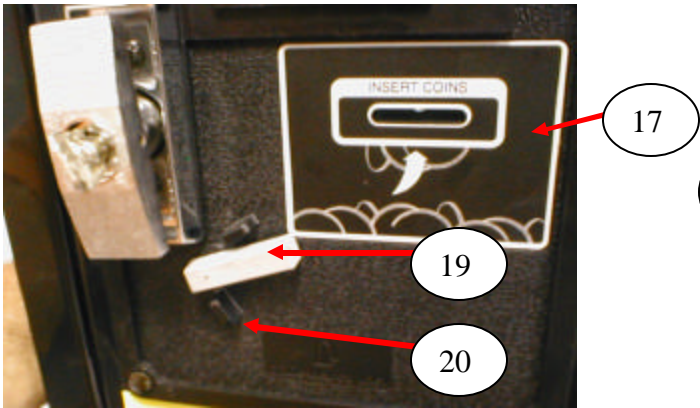
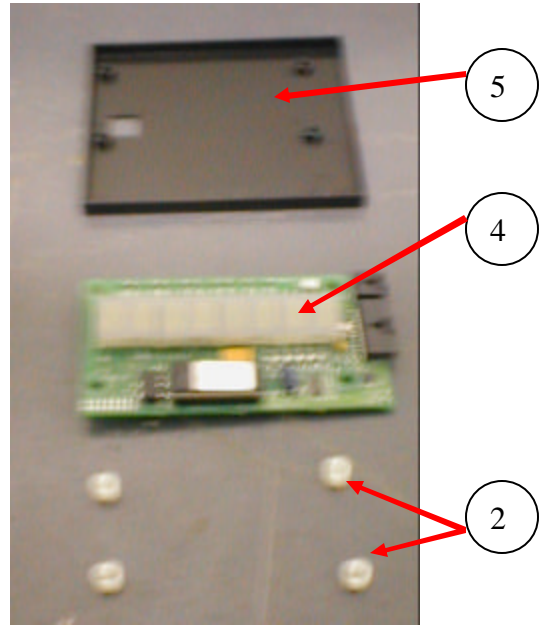
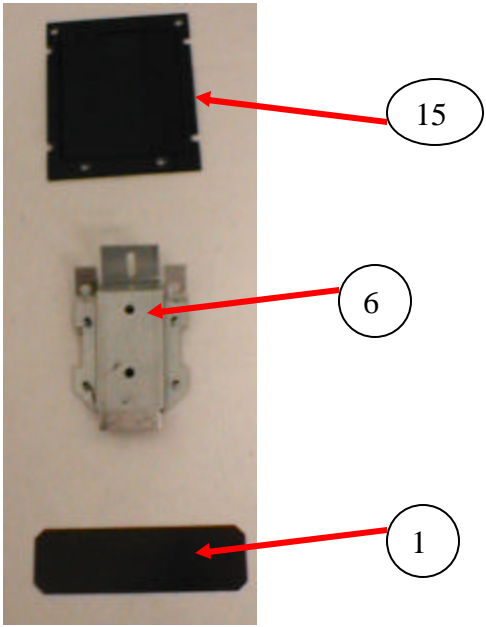

SERVICE DOOR 2

ITEM	PART DESCRIPTION	
1	Display Filter, Red	W367
2	Display Spacer – standoff	901,001,46x.x1
3	Bearing Sleeve, Service Door (not shown)	W737
4A	*Assembly, Display IR Capable (installed production 6206AB)	804,919,95x.x1
4B	Assembly, Display 8 Digit 14 Segment (installed prior to 6206AB) was 804,914,89x.x1	*RB 4A
5	Cover, Display	W121
6	Coin Chute Assembly (0041-8019BX & higher)	622,052,20x.x3
	Coin Chute Assembly (prior to 0041-8019BX)	622,051,00x.x3
7	Cotter Pin (Offset Head) was A007-1	800,903,35x.x1
8	Cam, Coin Return	W329
9	Coin Return Cam Shaft	800,502,96x.x1
10	Spacer, Unified ¼” Long	801,903,69x.x1
11	Coin Return Cup (0041-8019BX & higher)	801,810,14x.x1
	Coin Return Cup (prior to 0041-8019BX)	622,051,20x.x3
12	Change Cup Extension	491,011,16x.x3
13	Coin Return Door Flap (prior to 0041-8019BX)	622,050,14x.x3
14	Keypad, Cable Clamp Kit (not shown)	D114
15	Validator Filler Plate (All Dixie-Narco built doors)	360,050,72x.x3
	Validator Filler Plate (All ECC built doors)	F283
16	Gasket, Validator Filler Plate	902,001,11x.x1
17	Coin Insert Label – Service Door Bezel Domestic	803,902,72x.x1
	Coin Insert Label – Service Door Bezel Large Export	803,902,74x.x1
18	*Harness, IR Capable Display (installed production 6206AB)	804,919,99x.x1
	Harness Display - Grey Ribbon (installed prior to production 6206AB) was W344	804,913,68x.x1
19	Assembly, Coin Return Lever	800,502,98x.x1
20	Coin Return Lever Limiter	801,305,22x.x1
21	Latch, Pawl – 3 point Lock	801,518,05x.x1

*IR Capable Display (4) is backward compatible, but IR Capable Harness 18 needs to be used with the IR Capable Display.
 Part numbers & descriptions are subject to change with out notice.
 NA = Not applicable TBD = To be determined RB = Replaced by

SERVICE DOOR 3

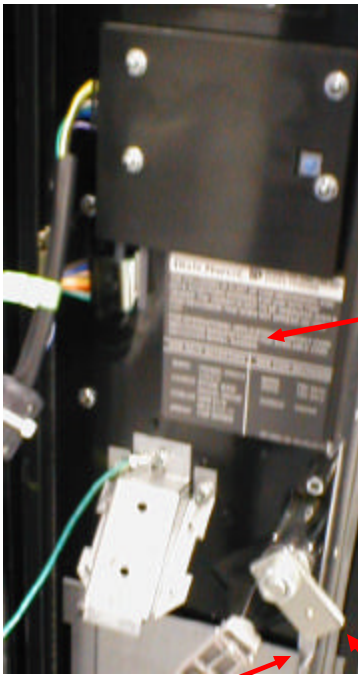
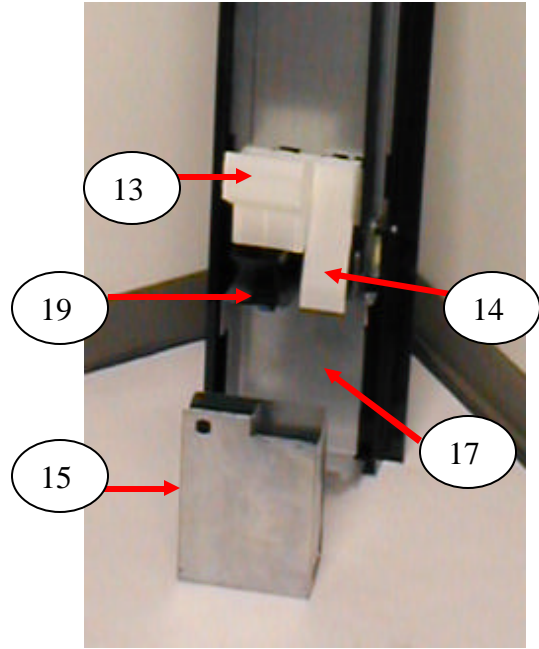
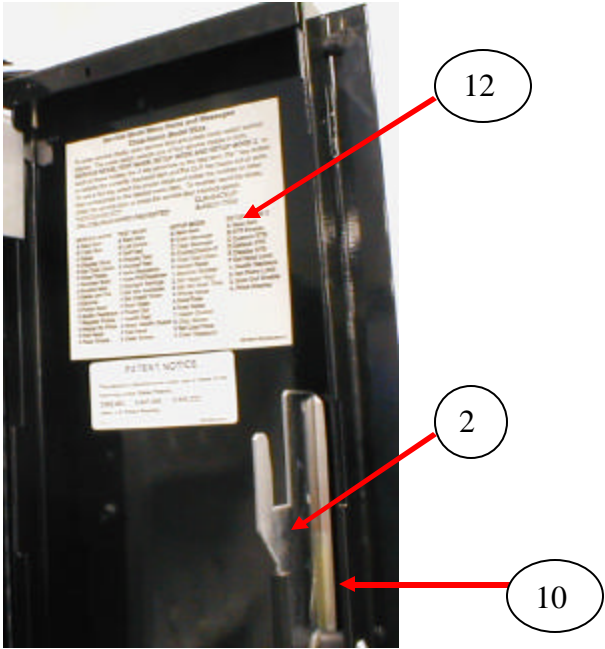

SERVICE DOOR 3

ITEM	PART DESCRIPTION	
1	Insert, Service Door – 3 Point Lock was F557	801,817,49x.x1
2	Latch Bar – 3 Point Lock (8072 & higher)	800,503,31x.x1
	Latch Bar – 3 Point Lock (prior to 8072)	800,503,22x.x1
	Bottom Latch – 3 Point Lock	801,305,58x.x1
3	Phillips Trusshead Screw #10-32x3/8 was 900,201,87x.x1	800,202,65x.x1
4	Insert Assembly Spacer – 3 Point Lock was F240-3	801,817,47x.x1
5	Washer, Flat .191 ID .50 OD .054T was 900,701,10x.x1	800,701,52x.x1
6	Washer, Flat .260 ID x .687 OD	900,701,22x.x1
7	Screw, Shoulder 10-32x1/4 was 900,202,03x.x1	800,202,55x.x1
8	Latch, Pawl – 3 Point Lock	801,518,05x.x1
9	Latch, Rod – 3 Point Lock	627,050,04x.x3
10	Protective Strip, Plastic (2 piece)	801,810,07x.x1
11	Keypad Cable Clamp	D588
	Keypad Cable Clamp Kit	D114
12	Service Menu Label DN Energy Star	803,876,27x.x1
	Service Menu Label DN Non - Energy Star	803,853,26x.x1
13	Hopper and Coin Chute	801,806,58x.x1
14	Coin Chute Front	801,806,59x.x1
15	Cash Box	432,051,80x.x3
16	Cash Box Clip	801,814,68x.x1
17	Cash Box Shelf	627,050,37x.x3
18	Locking Cash Box Kit	432,011,50x.x4
19	Change Cup	801,810,14x.x1
20	Coin Mech Label	803,853,25x.x1
21	Lanyard, Service Door (prior to DN2145)	W396
Part numbers & descriptions are subject to change with out notice. NA = Not applicable TBD = To be determined RB = Replaced by		

TALL GATE TRAY DETAIL

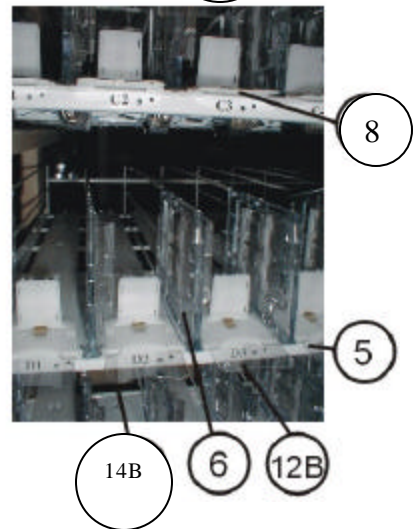
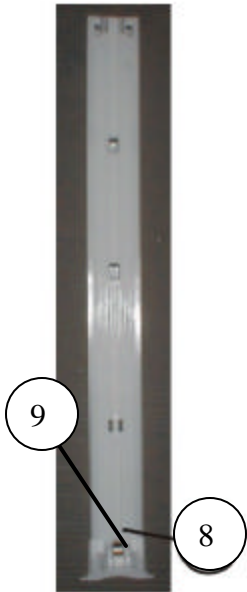
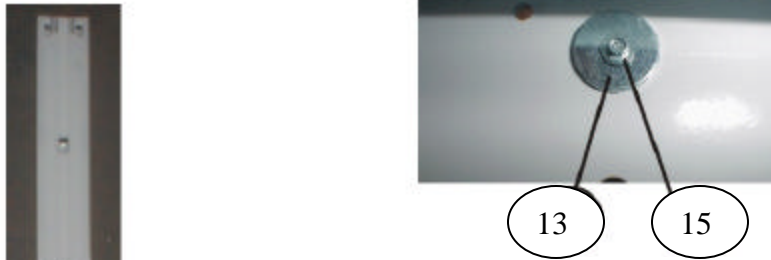
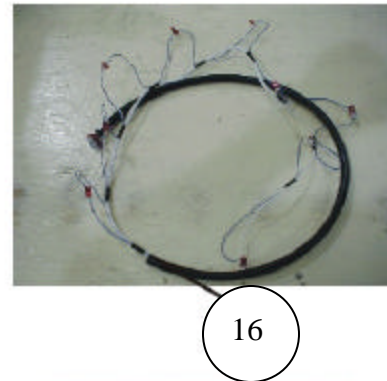
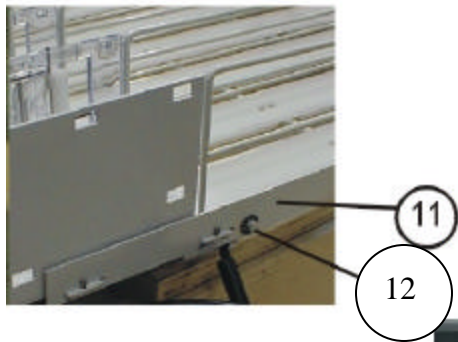
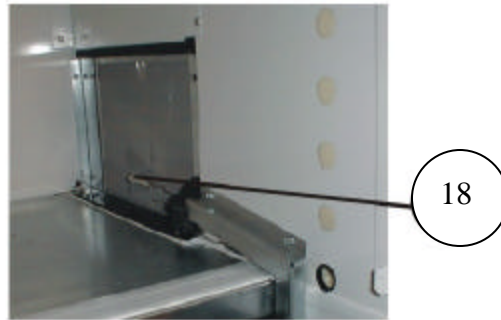
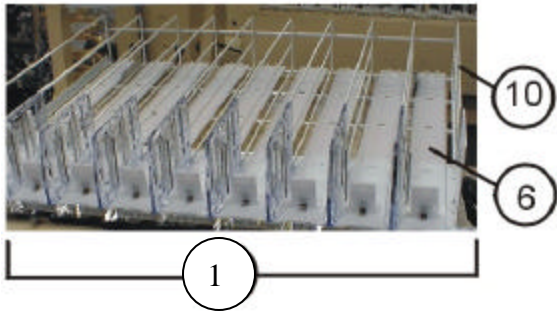
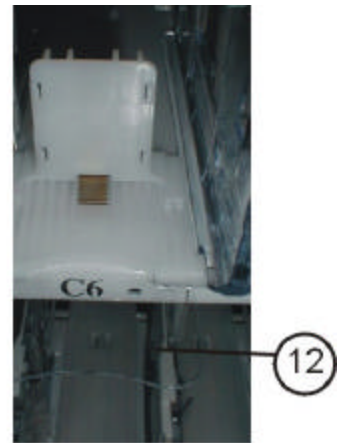
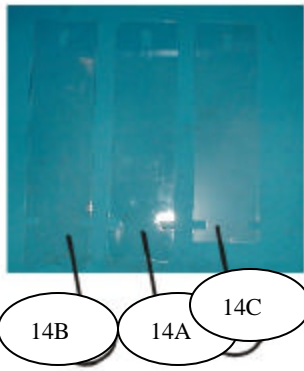
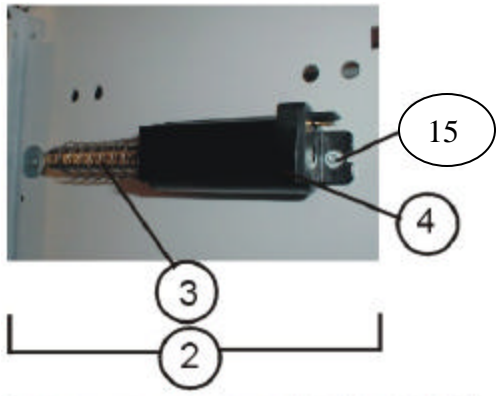

TALL GATE TRAY DETAIL

ITEM	PART DESCRIPTION	Domestic	Export
1	Tray Assy. Clear, 9 Column DN55## (0001-8107 & higher)	627,070,80x.x3	NA
	Tray Assy. White, 9 Column DN55## (0001-8107 & higher)	627,071,90x.x3	NA
	Tray Assy., 9 Column DN55##/2145 (prior to 0001-8107)	622,071,10x.x3	622,070,70x.x3
	Tray Assy., 8 Column DN5483	622,053,00x.x3	NA
	Tray Assy., 6 Column DN35##	635,070,00x.x3	TBD
2	Solenoid, 24 Volt w/ Plunger and Spring Assembly Kit	622,052,60x.x4	Same
3	Plunger and Spring was 801,519,29x.x1	801,521,07x.x1	Same
4	Body	804,300,16x.x1	Same
5	Chassis Tray, Tall Gate 9 Column DN55##	626,070,09x.x3	Same
	Chassis Tray, Tall Gate 8 Column DN55##	622,070,08x.x3	Same
	Chassis Tray, Tall Gate 6 Column DN35##	635,070,01x.x3	Same
6	Gate Assy. Clear, w/ Kicker (in production starting 8054)	801,903,83x.x1	Same
	Gate Assy. White, w/ Kicker	801,822,56x.x1	
7	Cotter Pin, .076 Dia. .500 Lg. was W789	800,903,29x.x1	Same
8	Slide with Product Pusher Assy (8054 and up) (Tall Gate Only)	801,818,14x.x1	Same
9	Product Pusher Spring – New (Z end)	801,701,13x.x1	Same
	Product Pusher Spring – New, stronger (service item only)	801,701,58x.x1	Same
	Product Pusher Spring – Old (hook end)	901,701,08x.x1	Same
10	Tray Wire, Formed Domestic 9 Column DN55##	801,401,98x.x1	801,401,89x.x1
	Tray Wire, Formed Domestic 8 Column DN55##	801,401,96x.x1	Same
	Tray Wire, Formed Domestic 6 Column DN35##	801,402,21x.x1	Same
11	Stiffener, Side Shelf	622,070,04x.x3	Same
12	Washer, Retainer - .125 ID was W398	800,701,71x.x1	Same
13	Washer, Solenoid Mounting	801,813,06x.x1	Same
14A	Stabilizer "C" Tray (Short)	801,903,63x.x1	Same
14B	Stabilizer "D" Tray (Long)	801,903,64x.x1	Same
14C	Stabilizer, Special	801,903,85x.x1	Same
15A	Screw, HiLo Hex head (Gate assy screw) was 800,303,64x.x1	800,304,17x.x1	Same
	Screw, Hex Washer 4-24x3/4 (Gate assy screw) was D334	800,304,17x.x1	Same
15B	3/16" Socket, 1/4" Drive (Apex 1106)	800,102,52x.x1	Same
	1/8" Socket. 1/4" Drive (Apex 1104)	800,101,94x.x1	Same
16	Tray Harness 9 Column	804,913,74x.x1	Same
	Tray Harness 8 Column	804,913,74x.x1	Same
	Tray Harness 6 Column	804,920,34x.x1	Same
17	Kit 6 to 5 Tray Conversion (3 new Trays and Brackets)	622,010,00x.x4	Same
	Kit 6 to 5 Tray Conversion (5 new Trays and Brackets)	622,010,10x.x4	Same
18	Temperature Control Clip	800,902,63x.x1	Same

Part numbers & descriptions are subject to change with out notice.
 NA = Not applicable TBD = To be determined RB = Replaced by

TALL GATE SPACERS

ITEM	PART DESCRIPTION	
	Spacers (refer to TB 514 for a more complete list)	
1	Spacer, Tall Gate 3/16" (.155) was W212-1	801,813,63x.x1
2	Spacer, Tall Gate, 3/8" (.340) was W212-2	801,813,62x.x1
3	Spacer, "C" (150 / 70)	801,812,02x.x1
4	Spacer "A" (210 / 70)	801,812,69x.x1
5	Spacer (340 / 210)	801,812,98x.x1
6	Spacer "B" (90 / 70)	801,812,81x.x1
7	Spacer (340 / 210 / 777) was 801,813,53x.x1	801,817,39x.x1
8	Spacer (340 / 590)	801,813,71x.x1
9	Spacer (155 / 530) was 801,813,78x.x1	801,821,67x.x1
10	Spacer (155 / 405) was 801,813,76x.x1	801,817,38x.x1
11	Spacer Rail Assembly (metal) was 622,053,10x.x3	801,815,36x.x1
12	Product Pusher Rail	801,811,09x.x1
13	Spacer, Rail Plastic	801,815,32x.x1

Part numbers & descriptions are subject to change with out notice.
 NA = Not applicable TBD = To be determined RB = Replaced by

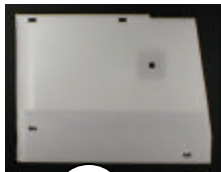

1

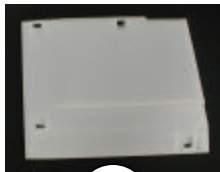

2



3

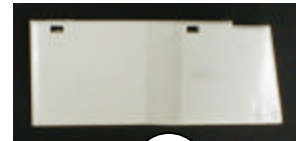

4

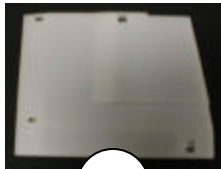

5

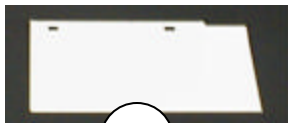

6



7



8



9



10

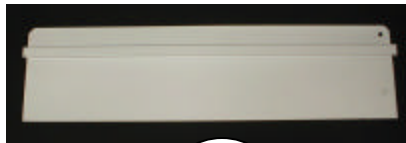

11



12



13

DOMESTIC AC DISTRIBUTION BOX, 110 VAC (Non Energy Star shown)

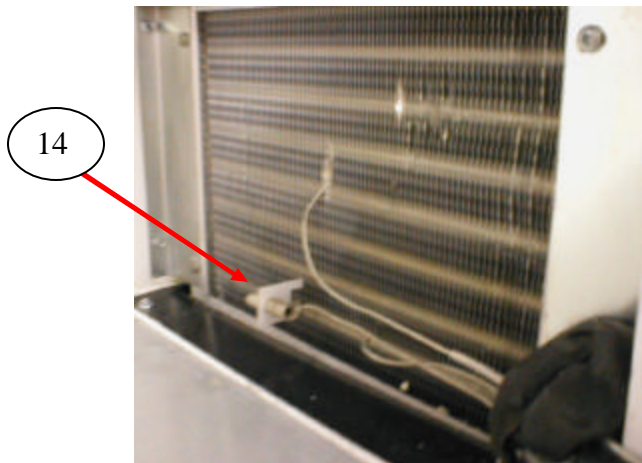
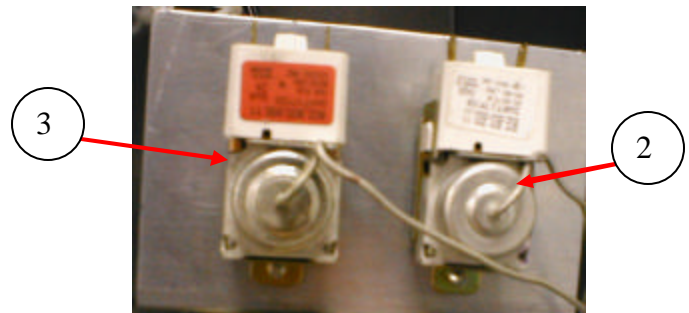
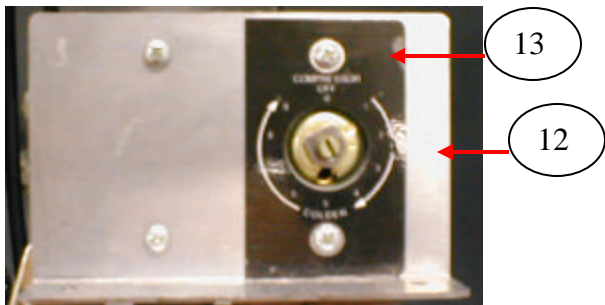
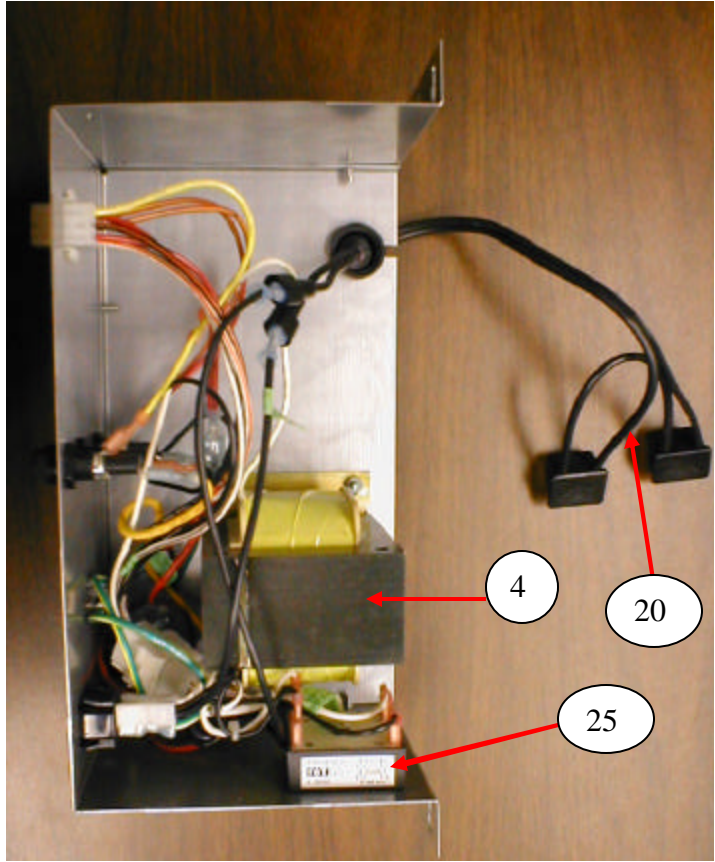
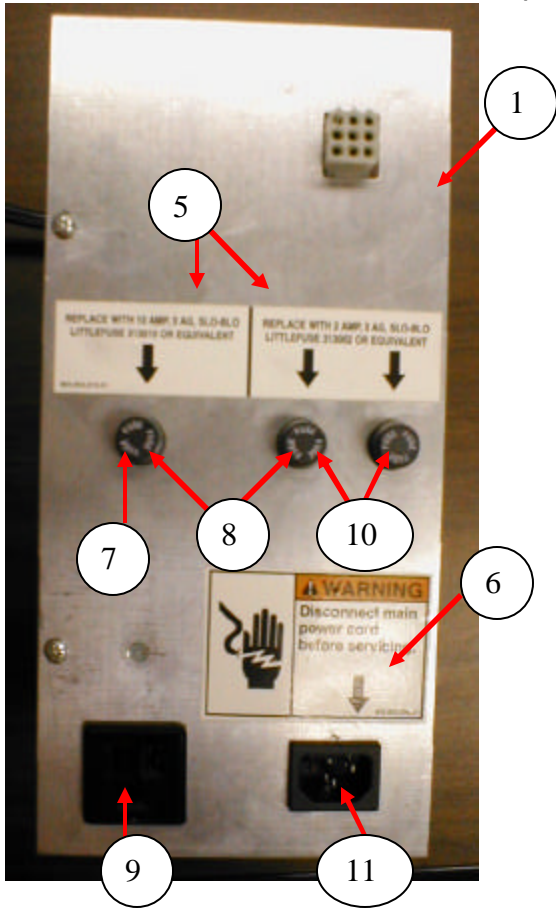

DOMESTIC AC DISTRIBUTION BOX, 110 VAC

ITEM	PART DESCRIPTION	
1	Assy. AC Distribution T8 Electronic GFV Energy Star (not shown)	635,060,70x.x3
	Assy. AC Distribution T8 Electronic GFV Non Energy Star (shown)	635,060,30x.x3
	Assy. AC Distribution GFV Non Energy Star	622,060,10X.X3
2	Defrost Thermostat GE (for dual control) (0016-8095 & higher)	802,800,60x.x1
3	Temperature Control GE (for dual control) (0016-8095 & higher)	802,800,66x.x1
	Temperature Control GE (for dual control) (prior to 0016-8095)	802,800,47x.x1
4	Transformer, 120V / 24V, 60 Hz, 8A Domestic was 804,913,73x.x1	804,915,54x.x1
5	2 Amp Fuse / 10 Amp Fuse Label	803,853,21x.x1
6	Label, Electrical Box, "WARNING – Disconnect Main Power Cord Before Servicing"	803,853,22x.x1
7	Fuse, 10 Amp, 32V SloBlo	W659
8	Fuse Holder, Panel Mounted, Quick Disconnect	804,920,02x.x1
9	Outlet, 15 Amp, Grounded	W662
10	Fuse, 2 Amp, 250V, SloBlo	W658
11	Power Inlet Plug	804,913,62x.x1
12	Dual Temperature Control Bracket (0016-8095 & higher)	622,060,13x.x3
	Dual Temperature Control Bracket (0086-8018 to 0016-8095)	491,070,08x.x3
	Hole Cover, AC Dist. Box for Temp. Control Relocation (prior to 0086-8018)	622,060,08x.x3
13	Temperature Control Label	803,847,08x.x1
14	Temperature Control Clip	800,902,63x.x1
15	Harness, AC Power Choke Input	804,920,56x.x1
16	Harness, AC Distribution Box Power	804,920,48x.x1
	Harness, AC Distribution Box Power	804,913,72x.x1
17	Harness, Choke Output	804,920,49x.x1
18	Harness, MDB Interior Power T8/Electronic GFV	804,920,55x.x1
	Harness, R, Interior Power GFV	804,913,75x.x1
19	Harness, Main Power	804,913,77x.x1
20	Harness, Dual Thermostat (0016-8095 & higher) was 804,914,39x.x1	804,925,92x.x1
21	Harness, Thermostat (069-8018 to 0016-8095) was 804,915,05x.x1	804,925,91x.x1
22	Harness, Power Distribution Domestic – Energy Star	804,922,93x.x1
23	Harness, Power & Choke Input – Energy Star	804,922,92x.x1
	Harness, AC Dist. Power In	804,913,71x.x1
24	Harness, Relay – Energy Star	804,922,94x.x1
25	Choke	804,920,41x.x1
26	Temperature Sensor, Energy Star	804,916,29x.x1
27	Harness, Temperature Sensor	804,917,24x.x1
28	Relay, Fan, Compressor, & Lights – Energy Star	804,200,26x.x1
29	Switch, Rocker, Panel Mount – Energy Star & prior to 0001-8000	804,915,15x.x1
Part numbers & descriptions are subject to change with out notice. NA = Not applicable TBD = To be determined RB = Replaced by		

EXPORT AC DISTRIBUTION BOX, 220 VAC

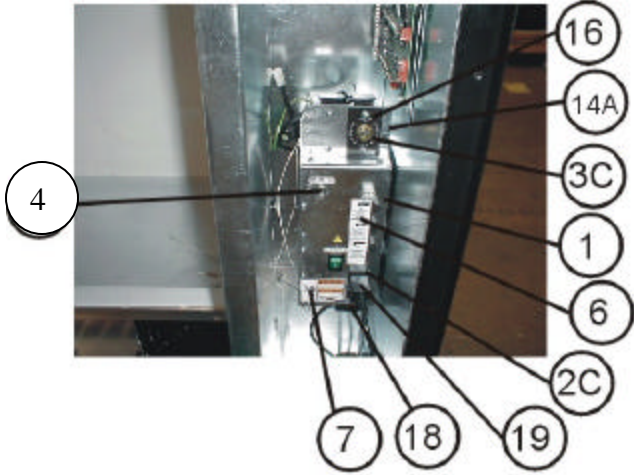

EXPORT AC DISTRIBUTION BOX, 220 VAC

ITEM	PART DESCRIPTION	
1	AC Distribution Box, Export CE / GS	622,061,40x.x3
2A	MDB Interior Power Harness	804,913,75x.x1
2B	Micro Mech Interior Power Harness	804,914,06x.x1
2C	AC Power-In Export Harness	804,914,94x.x1
3A	Thermostat, Cold Control (prior to 0016-8095)	802,800,75x.x1
3B	Export Defrost Thermostat GE (for dual control) (0016-8095 and higher)	802,800,70x.x1
3C	Export Cold Control GE (for dual control) (0016-8095 and higher)	802,800,76x.x1
4	3 Position Rotary Switch	804,916,93x.x1
5	Transformer, 230 V / 24 V, 50 Hz	804,914,18x.x1
6	Label, Fuse 10 Amp, 2 Amp and Lamp 250 V	803,857,55x.x1
7A	Label, AC Box, "WARNING – Disconnect Main Power Cord Before Servicing" (English)	803,853,22x.x1
7B	Label AC Box (German)	803,858,69x.x1
8	Fuse, 10 Amp, 250 V, 5x20 mm Sloblo	804,914,25x.x1
9	Fuse Holder, Export DN 2145 5x20 mm	804,914,88x.x1
10	Socket, 13 Amp, 250V British	F443
11A	Fuse, 2 Amp, 250 V 5x20 mm Sloblo	804,914,24x.x1
11B	Fuse, 1 Amp, 250 V 5x20 mm Sloblo	804,914,23x.x1
11C	Fuse, 1.25 Amp, 250 V, 5x20 mm Sloblo	804,919,56x.x1
12	Power Inlet Plug	804,913,62x.x1
13A	Thermostat Harness (068-8018 to 0016-8095) was 804,915,05x.x1	804,912,91x.x1
13B	Dual Thermostat Harness (0016-8095 and higher) was 804,914,39x.x1	804,925,92x.x1
14A	Dual Temp Control Bracket (0016-8095 and higher)	622,060,13x.x3
14B	Temperature Control Bracket (086-8018 to 0016-8095)	491,070,08x.x3
15	AC Distribution Box Hole Cover for Temperature Control Relocation (prior to 086-8018)	622,060,08x.x3
16	Temperature Control Label	803,847,08x.x1
17	Temperature Control Clip	800,902,63x.x1
18	Green Rocker Switch	804,101,12x.x1
19A	Main Power Cord 220 V Export (Europe) – Schuko	804,914,17x.x1
19B	Power Cord United Kingdom 78" – 3 Pin	804,918,72x.x1
19C	Main Power Cord 220 V Australia	804,914,87x.x1
19D	Power Cord Denmark	804,917,77x.x1
19E	Power Cord Israel	804,917,78x.x1
19F	Power Cord South Africa	804,919,49x.x1

Part numbers & descriptions are subject to change with out notice.
 NA = Not applicable TBD = To be determined RB = Replaced by

**REFRIGERATION UNIT
(DN 55##/35## FIN & TUBE CONDENSER)**

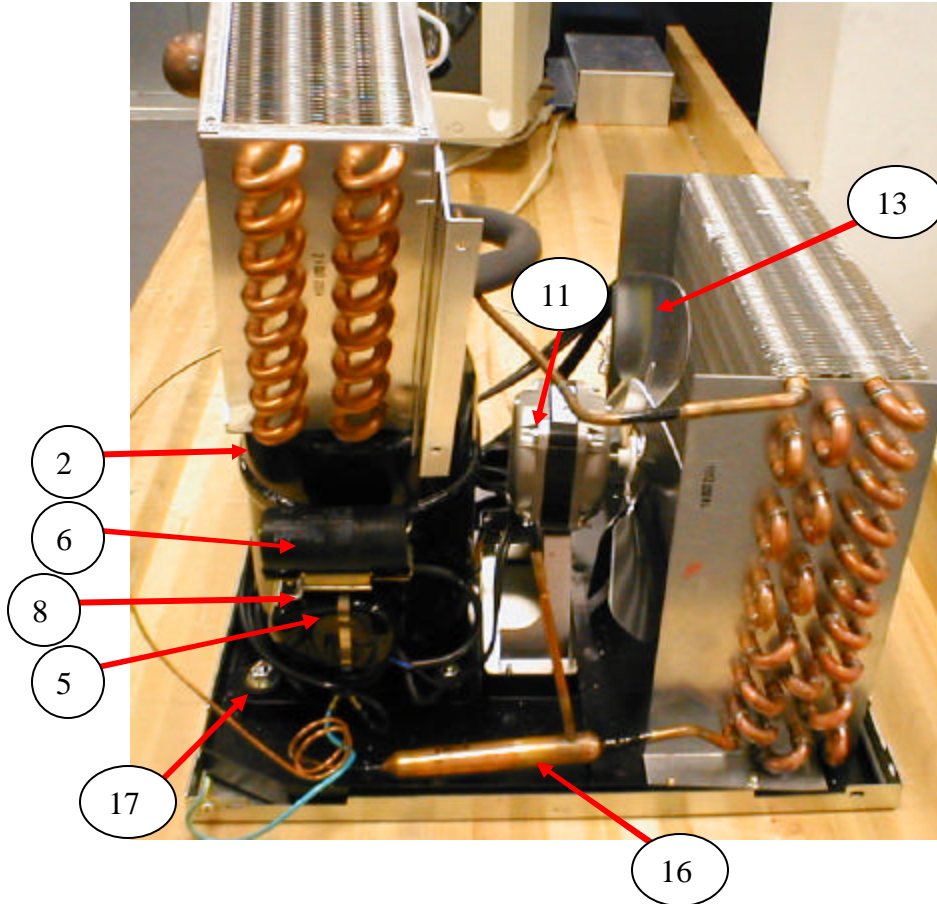
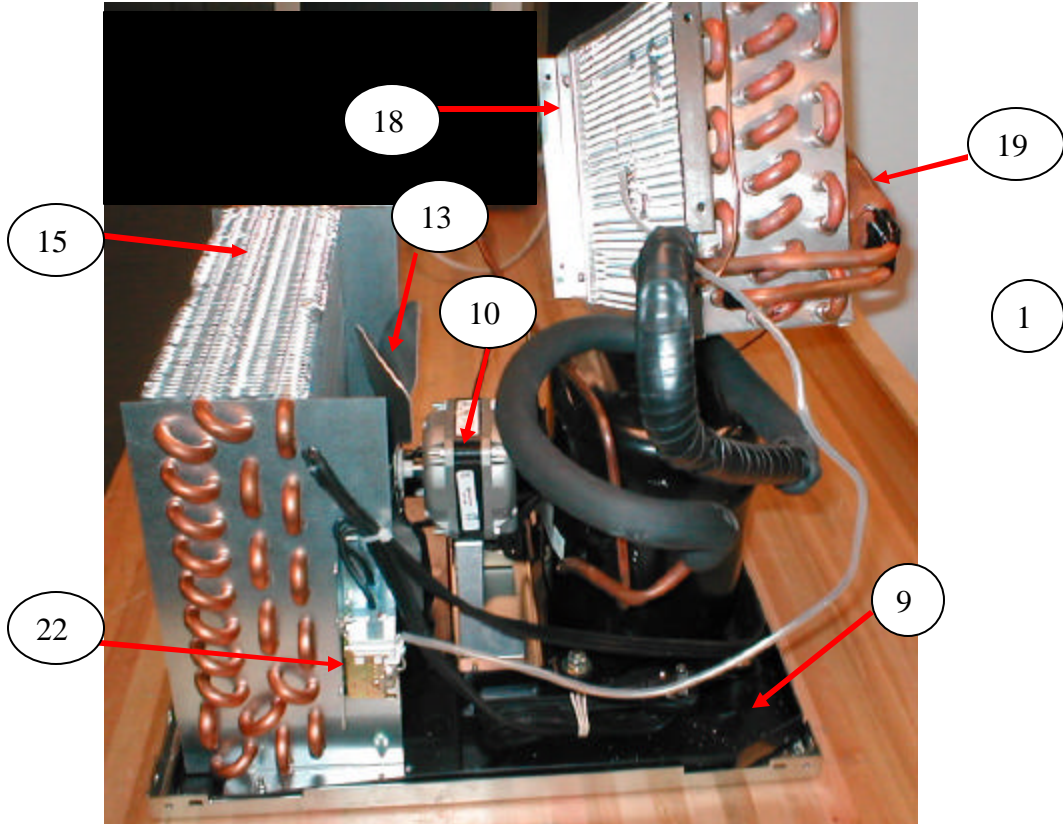

**REFRIGERATION UNIT
(DN 55##/35##/2145 FIN & TUBE CONDENSER)**

ITEM	PART DESCRIPTION	
1A	Refrigeration Unit EM2001 C-A Kit, 115V/60Hz Domestic Kit	635,040,00x.x4
	Refrigeration Unit EM2021 Kit, 220V Export Kit	635,040,20x.x4
1B	Refrigeration Unit EM2001 C-A, 115V/60Hz Domestic	635,050,06X.X3
	Refrigeration Unit EM2021, 220V Export	TBD
2	Compressor Assy. T6213Z 115V/60Hz Domestic	626,040,60X.X3
2A	Compressor, "A" T6213Z Domestic	802,502,22x.x1
2B	Compressor, "A" T6213Z 220-240V/50Hz Export	626,041,30x.x3
3A	Overload, T1, 115V, MST 16 AFN-3001 Domestic	802,502,23x.x1
3B	Overload, T1, 220V, MRP 20APK-34 Export	802,502,26x.x1
4A	Relay, 110V – Domestic	802,500,94x.x1
4B	Relay, 220V – Export	802,502,27x.x1
5	Cover, Overload/Relay Tecumseh	802,502,01x.x1
6A	Start Capacitor, 110V – 189227 Domestic	802,502,24x.x1
6B	Start Capacitor, 250V/50Hz (88-108MFD) Export	802,502,28x.x1
7	Start Capacitor, End Cap Bottom Hole	802,501,18x.x1
8	Bracket, Capacitor Assembly	802,501,87x.x1
9A	Drain Pan, Condensate - Domestic	801,812,61x.x1
9B	Drain Pan, Condensate - Export	801,813,55x.x1
10A	Assembly Condenser Fan 16W, 110V, 10" Domestic	626,040,70x.x3
10B	Assembly Condenser Fan 16W, 220V, 10" Export	626,041,40x.x3
11A	Condenser Fan Motor 16W, 110V Domestic	804,501,14x.x1
11B	Condenser Fan Motor 16W, 220V Export	804,501,18x.x1
12	Silencer	902,100,29x.x1
13	Fan Blade, Condenser – FV 100CW25S	801,305,67x.x1
14	Speed Nut	900,800,85x.x1
15	Condenser	802,600,64x.x1
16	Dryer, .064 EXTND OUTLET R134A	802,401,30x.x1
17	Grommet Compressor	902,000,57x.x1
18	Evaporator was W353	802,600,63x.x1
19	Accumulator, 1.375 OD x 6.875 L	802,401,35x.x1
20	Harness, Temperature Sensor	804,917,24x.x1
21	Temperature Sensor was W403	804,916,29x.x1
22	Defrost Control	802,800,70x.x1

Part numbers & descriptions are subject to change with out notice.
 NA = Not applicable TBD = To be determined RB = Replaced by

**REFRIGERATION UNIT – TECUMSEH
(DN 5500 / DN 5400 / DN 2145 – ROLL UP CONDENSER)**

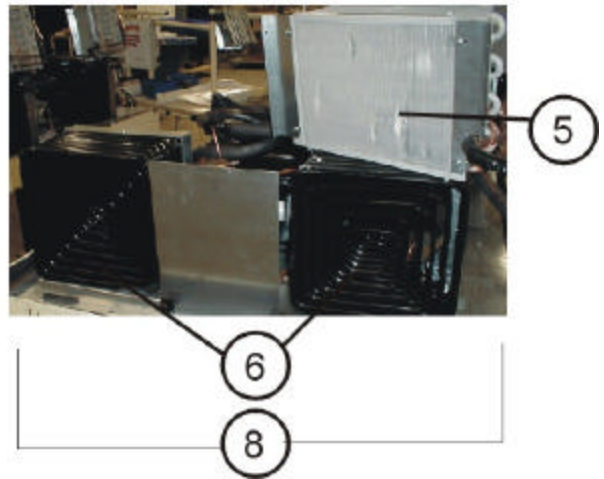
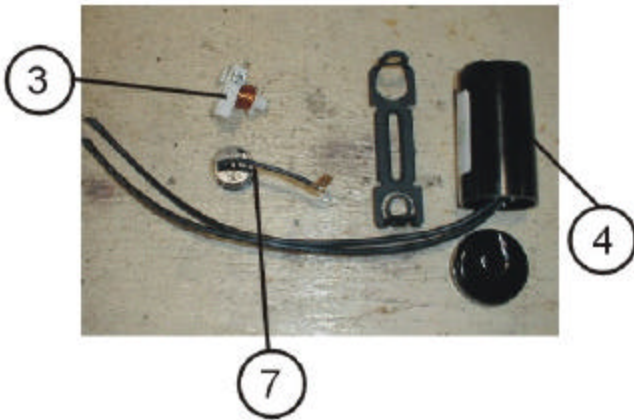
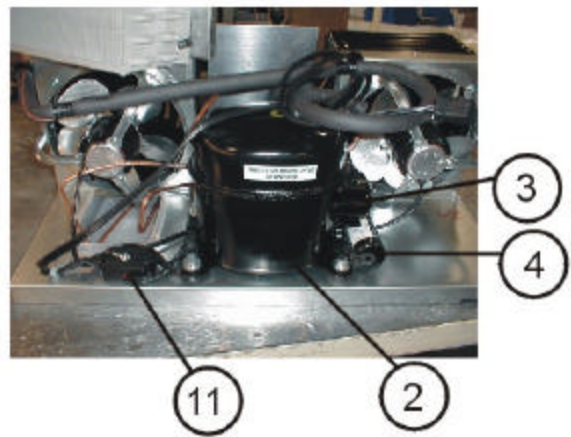
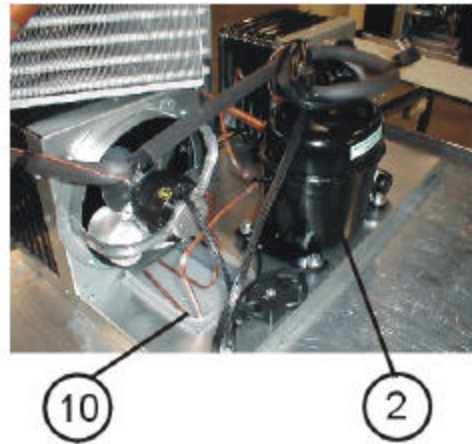
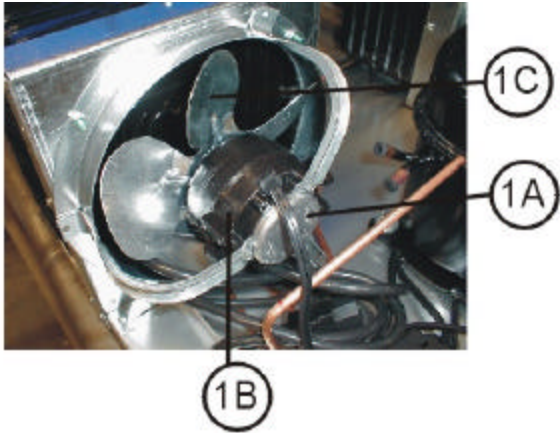

**REFRIGERATION UNIT – TECUMSEH
DN 5500 / DN 5400 / DN 2145 – ROLL UP CONDENSER)**

ITEM	PART DESCRIPTION	
1A	Condenser Fan Assembly, 115V/60Hz, 9W, 8" was D029	804,501,19x.x1
	Condenser Fan Assembly, 220-230V/50Hz, 9W, 8"	804,501,10x.x1
1B	Condenser Fan Motor, 115V/60Hz, 9W	F470
	Condenser Fan Motor, 230V/50Hz, 9W was F471	obsolete
1C	Condenser Fan Blade, 8" FV 800 CW 305	F469
2	Compressor, 115V/60Hz Aspera T6213Z ½ HP	802,502,22x.x1
	Compressor, 220V/50Hz Tecumseh ½ HP was W290	obsolete
	Compressor, 220-230V/50Hz Aspera T6213Z ½ HP	802,502,25x.x1
3	Relay, 110V	802,500,94x.x1
	Relay, 220V - Tecumseh	D609-2
	Relay, 220V	802,502,27x.x1
4	Start Capacitor, 165V – Tecumseh	D610-1
	Start Capacitor, 330V – Tecumseh	D610-2
	Start Capacitor, 189227 60 Hz	802,502,24x.x1
	Start Capacitor, 250 V / 50 Hz (88-108MFD)	802,502,28x.x1
5	Evaporator was W353	802,600,63x.x1
6	Condenser, Roll Up was 802,600,62x.x1	obsolete
7	Overload, 110V – Tecumseh	D608-1
	Overload, 220V – Tecumseh	D608-2
	Overload, T1, 115V – Aspera (MST 16 AFN-3001)	802,502,23x.x1
	Overload, T1, 220V – Aspera (MRP 20APK-34)	802,502,26x.x1
8	Refrigeration Kit 115V/60Hz 609,044,20x.x4 no longer available	RB 635,040,00x.x4
	Refrigeration Kit 220V/50Hz 609,045,90x.x4 no longer available	RB 635,040,20x.x4
9	Assy., Drain Pan Evaporator (not shown) was D034	622,041,20x.x3
10	Drain Pan 1600 C-A Unit / 1620 C-A was 622,040,12x.x3	801,817,84x.x1
11	Junction Box	804,601,48x.x1
12	Dryer (not shown) .064 EXTND Outlet R134A	802,401,30x.x1
13	Drain Tube was W348	801,817,41x.x1
14	Harness, Temperature Sensor	804,917,24x.x1
15	Temperature Sensor was W403	804,916,29x.x1

Part numbers & descriptions are subject to change with out notice.
NA = Not applicable TBD = To be determined RB = Replaced by

ELECTRONICS

ITEM	PART DESCRIPTION	Energy Star	Non Energy Star
1	Control Board, New (includes vend sensor adapter board)	627,021,90x.x4	627,021,20x.x3
	Control Board, Reconditioned (includes vend sensor adapter board)	627,022,00x.x4	495,061,17x.x3
2	EPROM, Firmware	804,917,030.81	804,917,03x.x1
	EPROM, Firmware (must be 030.61 to work with non IR Display)	NA	804,917,030.61
3	Assembly, Display IR Capable (production run 8206AB)	804,919,95x.x1	Same
	Assembly, Display 8 Digit, 14 Segment - 804,914,89x.x1	NA	RB 804,919,95x.x1
4	Display, 14 Segment Character	804,912,79x.x1	Same
5	Transformer was 804,913,73x.x1	804,915,54x.x1	Same
6	Fuse, AC Distribution Box – 10 Amp SloBlow .32V	W659	Same
7	Fuse, AC Distribution Box – 2 Amp, 250 Volt SloBlow	W658	Same
8	Battery, 3 Volt Lithium CR2032	804,920,45x.x1	Same
9A	Lighted Vend Sensor Kit	627,022,10x.x4	Same
9B	Lighted Vend Sensor	804,924,07x.x1	Same
9C	Directional Disc (2 per order needed)	804,801,08x.x1	Same
10	Temp Sensor	804,917,24x.x1	Same
11	Temp Sensor Control Board was W403	804,916,29x.x1	Same
12	Dual Vend Sensor Adapter Board	804,922,56x.x1	804,920,40x.x1

Part numbers & descriptions are subject to change with out notice.
 NA = Not applicable TBD = To be determined RB = Replaced by

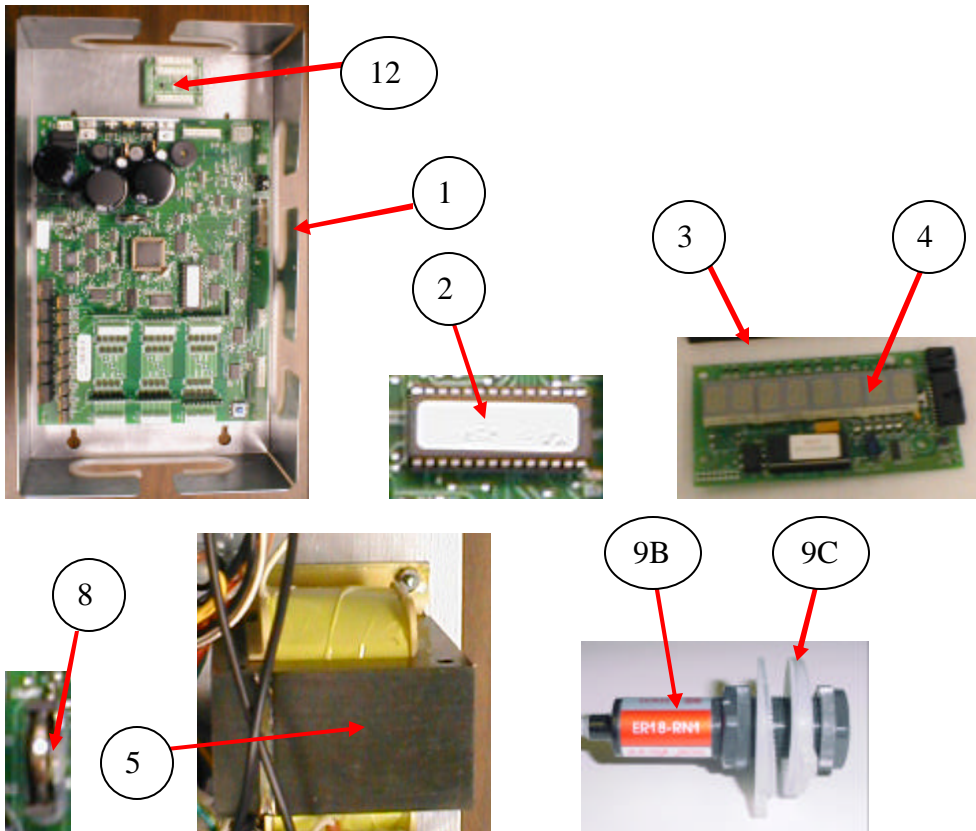

HARNESSES

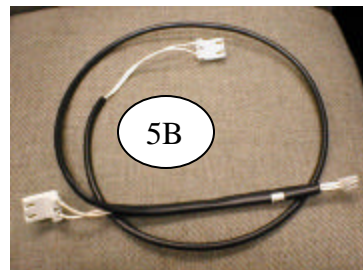
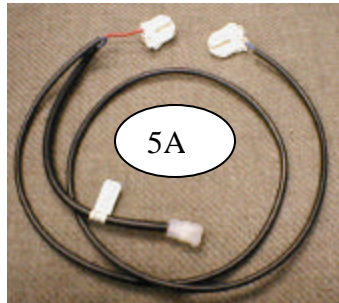
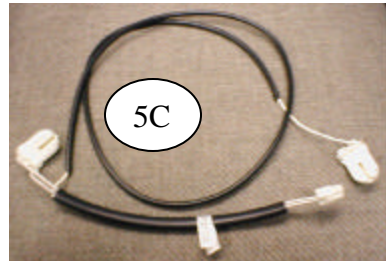
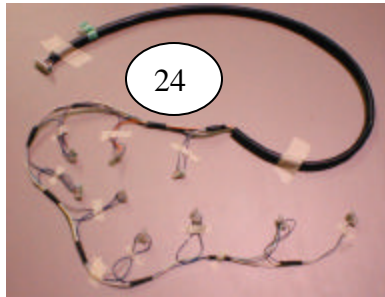
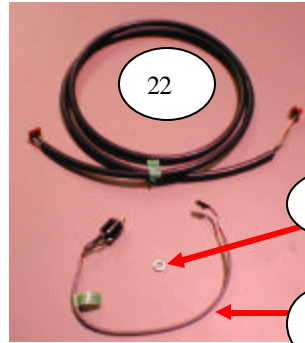
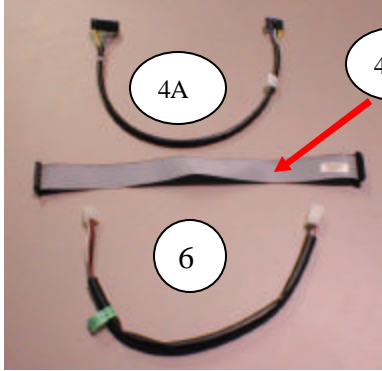
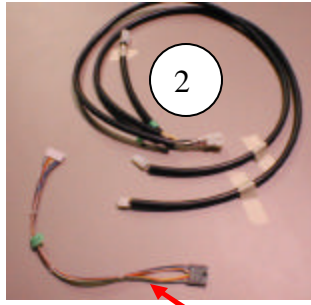

HARNESSES

ITEM	PART DESCRIPTION	
1	Harness, Controller Board to Door Switch	804,918,24x.x1
	Harness, Controller Board to Door Switch was W390	804,913,67x.x1
2	Harness, Power to Controller Board	804,913,75x.x1
3	Harness, Controller Board to Keypad	804,913,69x.x1
4A	Harness, Controller Board to IR Capable Display (start 6206AB)	804,919,99x.x1
4B	Harness, Controller Board to Display (prior to 6206AB) was W344	804,913,68x.x1
5A	Harness, Light GFV 120V T8 Electronic (0304-8225 & higher)	804,920,51x.x1
5B	Harness, Light GFV 120V T8 Magnetic Rapid Start (prior to 0304-8225)	804,913,78x.x1
5C	Lighting Harness 220-240V	804,926,04x.x1
6A	Harness, MDB Coin Mech 16"	804,920,25x.x1
6B	Harness, MDB Coin Mech was 804,913,47x.x1	RB 6A
7	Harness, Main Power (115V)	622,060,60x.x3
	Harness, Main Power	804,913,77x.x1
8	Harness, DEX 66 '	804,907,83x.x1
9	Harness, DEX 15"	804,913,97x.x1
10	DEX Kit – Includes bracket, 15" harness, & hardware	627,020,30x.x4
10A	Hex Nut for DEX Harness Kit	800,801,65x.x1
10B	DEX Harness Bracket	627,010,02x.x3
10C	Harness, DEX 15"	See Item 9
11	Harness, Energy Star Evaporator Fan	804,922,37x.x1
	Harness, Energy Star Evaporator Fan Choke Extension	804,922,77x.x1
12	Harness, AC Power Choke Input	804,920,56x.x1
13	Harness, AC Box Power Distribution	804,920,48x.x1
14	Harness, Jumper AC Refrigeration	804,913,79x.x1
15	Harness, Choke Output	804,920,49x.x1
16	Harness, Interior Power T8 Electronic (0304-8225 & higher)	804,920,55x.x1
	Harness, R, Interior Power (prior to 0304-8225)	804,913,75x.x1
17	Harness, Thermostat Dual (0016-8095 & higher) was 804,914,39x.x1	804,925,92x.x1
	Harness, Thermostat (0069-8018 to 0016-8095) was 804,915,05x.x1	804,925,91x.x1
18	Harness, Temperature Sensor was F184	804,917,24x.x1
19	Harness, Jumper 10 Motor	804,923,21x.x1
20	Harness, Tray 9 Column was W345	804,913,74x.x1
21	Harness, Tray 8 Column	804,913,74x.x1
22	Harness, Tray 6 Column	804,920,34x.x1
23	Harness, Power Distribution Domestic – Energy Star	804,922,93x.x1
24	Harness, Power & Choke Input – Energy Star	804,922,92x.x1
	Harness, AC Dist. Power In	804,913,71x.x1
25	Harness, Relay – Energy Star	804,922,94x.x1

Part numbers & descriptions are subject to change with out notice.

NA = Not applicable TBD = To be determined RB = Replaced by

LABELS / DECALS / MISC.

ITEM	PART DESCRIPTION	DN55##	DN35##
1	Vender Lag Bracket Kit (0001-8124 & higher)	627,020,60x.x4	Same
2	Wall Stand-Off Bracket Kit (prior to 0001-8124)	D014	Same
3	DEX Kit – Includes bracket, 15” harness, & hardware	627,020,30x.x4	Same
4	Thermometer	801,401,55x.x1	Same
5	Label Set, Price and Product was W485	803,881,99x.x1	Same
6	Label Set, Product Only (i.e. A1, A2, etc.) was W485-1	803,857,26x.x1	Same
7	Label, Open Bottles Slowly	803,865,09x.x1	Same
8	Label, Package Setup Guide, Pepsi	803,865,55x.x1	Same
9	Label, Warning “DO NOT TILT”	803,868,29x.x1	Same
10	Label, Programming Energy Star	803,876,27x.x1	Same
	Label, Programming Non Energy Star	803,853,26x.x1	Same
11	Label, Coin Mech	803,853,25x.x1	Same
12	Label, Pricing Low	803,875,64x.x1	Same
13	Label, Pricing High	803,876,44x.x1	Same
14	Label, Common Package Spacer Set Up (Generic)	803,869,97x.x1	Same
15	Label, Coin Return Service Door Bezel	803,857,25x.x1	Same
16	Label, AC Distribution Box Power Disconnect	803,853,22x.x1	Same
17	Label, Coin Insert Service Door Bezel Domestic	803,902,72x.x1	Same
	Label, Coin Insert Service Door Bezel Large Export	803,902,74x.x1	Same
18	Decal, Side, Cabinet (Black)	W215	Same
	Decal, Side, Cabinet (Pepsi White Cap Bottle)	803,851,91x.x1	Same
	Decal, Side, Cabinet (Pepsi Blue Cap Bottle)	803,864,68x.x1	Same
19	Decal , Top Glass Door Domestic/Export	803,851,89x.x1	803,868,65x.x1
	Decal , Top Glass Door Enjoy	D621	Same
20	Decal, Bottom Glass Door (Pepsi)	803,851,94x.x1	803,868,66x.x1
	Decal, Bottom Glass Door	D618	Same
21	Decal, Top Service Door (Pepsi White Cap Bottle)	803,851,93x.x1	Same
	Decal, Top Service Door (Thirsty)	D622	Same
22	Decal, Bottom Service Door Domestic/Export (Pepsi)	803,872,63x.x1	Same
	Decal, Bottom Service Door (Help Yourself)	803,857,38x.x1	Same
23	Product ID Pusher Card Sheet Pepsi Domestic 1 was 803,862,39x.x1	803,876,32x.x1	Same
24	Product ID Pusher Card Sheet Pepsi Domestic 2 was 803,862,42x.x1	RB 23	Same
25	Product ID Pusher Card Sheet Generic Domestic 1 was 803,862,41x.x1	Obsolete	Same
26	Product ID Pusher Card Sheet Generic Domestic 2 was 803,862,42x.x1	Obsolete	Same
27	Product ID Pusher Card Sheet Britvic 1	803,864,12x.x1	Same
28	Product ID Pusher Card Sheet Britvic 2	803,864,13x.x1	Same
29	Product ID Pusher Card Sheet Generic Britvic 3	803,862,14x.x1	Same
30	Pepsi Manual, Service / Operation / Parts	803,902,68x.x1	Same
31	NAMA Instructions (Milk Venders)	NA	803,903,76x.x1
32	Foot Print Sheet	803,903,94x.x1	NA

Part numbers & descriptions are subject to change with out notice.

NA = Not applicable TBD = To be determined RB = Replaced by

SCREWS & NUTS

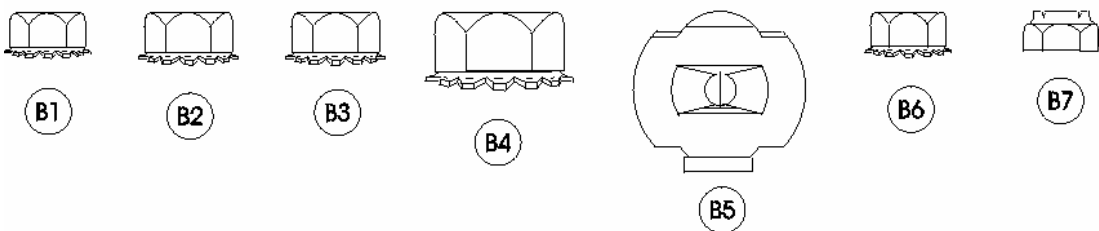
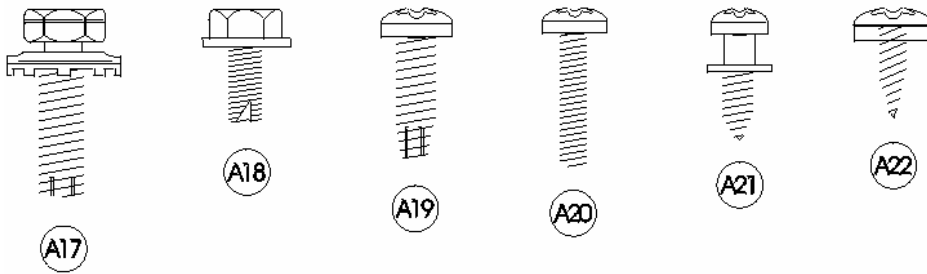
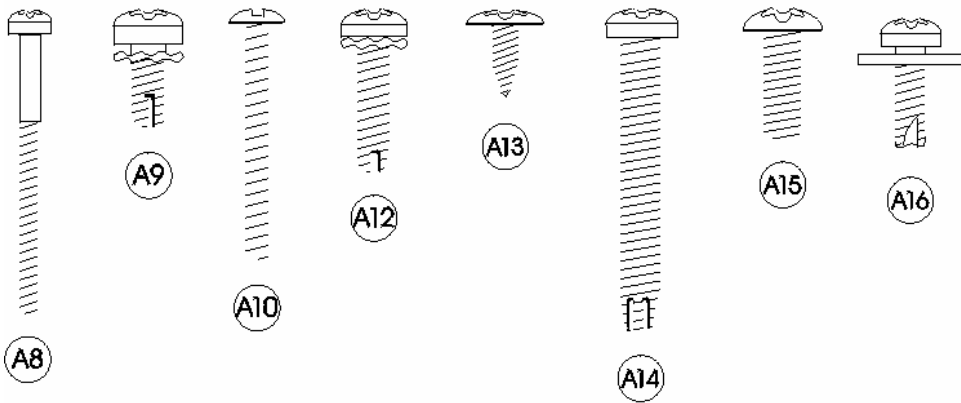
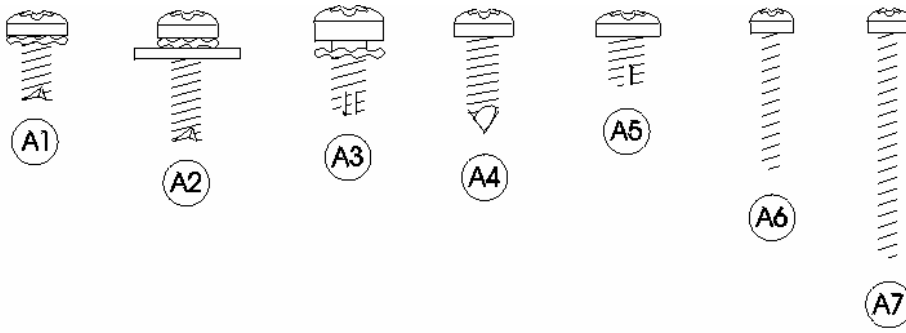

SCREWS & NUTS

ITEM	PART NAME AND DESCRIPTION	
A1	Screw, Phil Pan Swage Form #6 - 32 x 3/8" was 900,301,70x.x1	800,304,25x.x1
A2	Screw, Phil Pan Swage Form w/washer #8 - 32 x 1/2" was 900,301,64x.x1	800,304,39x.x1
A3	Screw, Phil Pan Swage Form #10 - 32 x 5/16" was 900,301,83x.x1	800,304,29x.x1
A4	Screw, Phil Pan w/out washer, #8 - 18 x 1/2" self driller was 900,301,50x.x1	800,304,18x.x1
A5	Screw, Phil Pan Swage Form #8 - 32 x 1/4" was 900,301,79x.x1	800,304,34x.x1
A6	Screw, Vend Motor, #4-24 x 3/4" Single Switch was 900,300,47x.x1	800,304,50x.x1
A7	Screw, Vend Motor, #4-24 x 1 1/16" Double Switch	900,301,82x.x1
A8	Screw, Vend Motor, #4-24 x 1 1/2" Triple Switch	900,301,61x.x1
A9	Screw, Phil Pan Cutting #8 - 32 x 3/8" was 900,301,56x.x1	800,304,22x.x1
A10	Screw, Machine, #6 - 32 x 1 1/4"	900,201,31x.x1
A11	Screw, Phil Pan Sems #8 - 32 x 1/4" was 900,301,97x.x1	800,304,34x.x1
A12	Screw, Phil Thread Form #8 - 32 x 5/8" was 900,301,85x.x1	800,304,32x.x1
A13	Screw, Phil Head Truss #6 x 3/8"	900,300,16x.x1
A14	Screw, Phil Pan Form #10 - 32 x 1 1/4" was 900,301,81x.x1	800,304,28x.x1
A15	Screw, Machine Truss, #10 - 32 x 1/2" was 900,201,14x.x1	800,202,52x.x1
A16	Screw, Phil Pan Sems with washer, #8 - 18 x 1/2" was 900,301,65x.x1	800,304,22x.x1
A17	Screw, Self Tapping, 1/4 - 20 x 5/8" was 900,302,01x.x1	800,304,36x.x1
A18	Screw, Hex Head Swage Form #8 - 36 x 3/8" was 900,301,69x.x1	800,304,24x.x1
A19	Screw, Phil Pan Tapping #10 - 32 x 5/8" was 900,901,51x.x1	800,304,41x.x1
A20	Screw, Machine Phil Pan #8 - 32 x 3/4" was 900,201,22x.x1	900,201,91x.x1
A21	Screw, Phil Pan Shoulder #8 - 18 x 1/2" was 900,301,98x.x1	800,305,06x.x1
A22	Screw, Phil Pan #8-18x1/2" was 900,301,84x.x1	800,304,31x.x1
A23	Shoulder Screw 1/2" Long	900,500,26x.x1
A24	Screw, Hex Head	900,201,13x.x1
A25	Screw, Tap 1/4-20x1" Hex Type F was 900,301,73x.x1	800,304,26x.x1
A26	Screw, Phil Pan #8-18x3/4" was 800,303,15x.x1	800,304,76x.x1
A27	Screw, Truss Type 23 #8-32x1/2 was 800,303,18x.x1	800,304,07x.x1
A28	Screw, Phil Flat 23B #10-32x1/2" was 900,301,94x.x1	800,304,33x.x1
A29	Screw, Machine Brass #6-32x1/4" was 900,201,44x.x1	800,202,44x.x1
A30	Screw, Plastic 8-hi/low x 1 1/4 was 900,301,99x.x1	800,304,35x.x1
A31	Screw, Phil Pan Swage Form #8-32x1/2" was 900,301,55x.x1	800,304,21x.x1
A32	Screw, Hex Washer Type 1 #8-32x3/8" was 900,303,08x.x1	800,304,38x.x1
A34	Screw, Phil Pan #6-20x3/8	800,303,22x.x1
A35	Screw, Self Tapping, #8-18x3/4 was 900,302,02x.x1	800,304,37x.x1
A36	Screw, Phil Pan Head #6-32x1/4" was 900,201,86x.x1	800,202,48x.x1
B1	Hex Nut, #10 - 32 was 900,800,65x.x1	800,801,56x.x1
B2	Hex Nut, 1/4 - 20 was 900,800,67x.x1	800,801,57x.x1
B3	Hex Nut, #8 - 32 was 900,800,50x.x1	800,801,54x.x1
B4	Hex Nut, Top Door Hinge, 3/8 - 16 was 900,800,69x.x1	800,801,83x.x1
B5	Speed Nut	900,800,85x.x1
B6	Hex Nut, #6 - 32 was 900,800,49x.x1	800,801,82x.x1
B7	Elastic Stop Nut, #8 - 32 was 900,800,51x.x1	800,801,55x.x1
B8	Hex Nut 8-32 was 900,800,81x.x1	800,801,84x.x1
B9	Push Nut, Acorn Type was 900,902,37x.x1	800,903,50x.x1
B10	Hex Nut 5/16-18 was 900,801,02x.x1	800,801,61x.x1
B11		
Part numbers & descriptions are subject to change with out notice. NA = Not applicable TBD = To be determined RB = Replaced by		

WASHERS, BOLTS, & MISC. HARDWARE

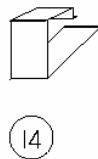
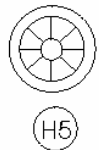
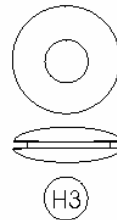
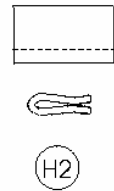
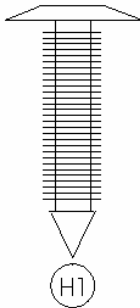
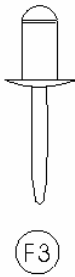
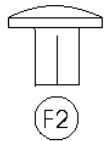
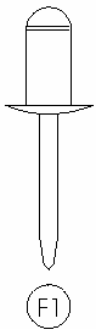
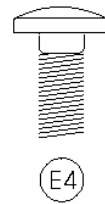
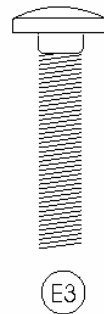
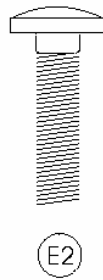
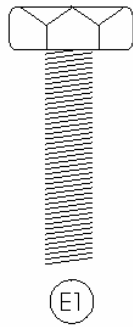
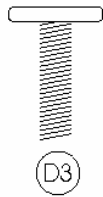
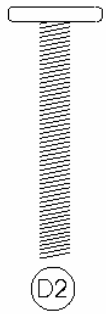
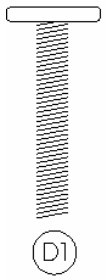
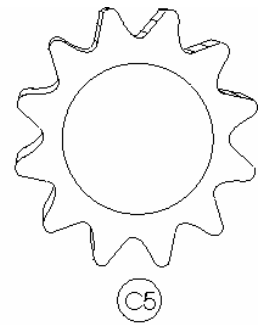
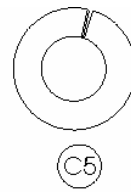
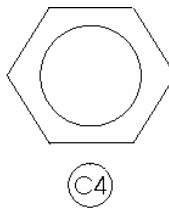
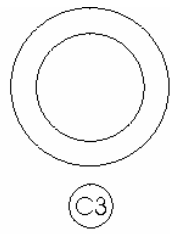
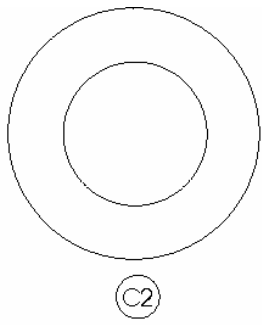
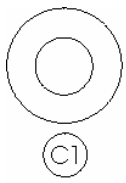

WASHERS, BOLTS, & MISC. HARDWARE

ITEM	PART NAME AND DESCRIPTION	
C1	Washer, Delrin .047 Thick 3/8"IDx5/8"OD was 900,700,60x.x1	900,701,22x.x1
C2	Washer, Door Hinge was 901,303,77x.x1	800,701,73x.x1
C3	Washer, Flat #2949 (T-Handle) was 901,503,06x.x1	800,701,72x.x1
C4	Washer, Hex #29-34 (T-Handle)	901,503,08x.x1
C5	Lockwasher, Split 3/8" was 900,700,36x.x1	800,701,43x.x1
C6	Lockwasher, Shakeproof 5/8" (1132-00-00-0551)	900,700,89x.x1
C7	Steel Washer, 18 Gauge (1/2"x3/16") was 900,700,02x.x1	800,701,74x.x1
C8	Washer, Shakeproof (4610-16-01-0551)	900,700,62x.x1
C10	Washer, Flat 18 Gauge (17/64""IDx5/8"OD) was 900,700,83x.x1	800,701,44x.x1
C11	Washer, Flat 14 Gauge (5/16"-3/8"x7/8") was 900,700,08x.x1	800,701,67x.x1
C12	Nylon Spacer	801,902,48x.x1
C13	Washer Flat (.343"ID x .688" OD .6T)	900,701,05x.x1
D1	T-Bolt, #8 - 32 x 1" was 900,400,43x.x1	obsolete
D2	T-Bolt, #8 - 32 x 1 3/8" was 900,400,41x.x1	800,400,68x.x1
D3	T-Bolt, #8 - 32 x 3/4" was 900,400,35x.x1	800,400.61x.x1
D4	T-Bolt, #8 - 32 x 1/2" was 900,400,45x.x1	800,400,62x.x1
E1	Refrigeration Bolt, 3/8 - 16 x 1 1/4" was 900,400,44x.x1 was 800,400,54x.x1	800,400,59x.x1
E2	Carriage Bolt, 1/4 - 20 x 1" was 900,201,17x.x1	800,202,42x.x1
E3	Carriage Bolt, 1/4 - 20 x 1 1/4" was 900,201,23x.x1	800,202,43x.x1
E4	Carriage Bolt, 1/4 - 20 x 1/2" was 900,201,45x.x1	800,202,45x.x1
E5	Carriage Bolt, 1/4 - 20 x 3/8" was 900,201,54x.x1	800,202,46x.x1
E6	Carriage Bolt, 1/4 - 20 x 3/4" was 900,201,56x.x1	800,202,47x.x1
E7	Carriage Bolt, 1/4-20x5/8" was 900,303,12x.x1	obsolete
E8	Carriage Bolt, 5/16x18x1 1/4" Top Hinge (drop in) was 900,201,85x.x1	800,202,54x.x1
E9	Carriage Bolt, 1/4-20x5/8" was 800,303,19x.x1	800,304,08x.x1
E10	Carriage Bolt, 1/4-20x1/2" (red) was 900,202,04x.x1	800,202,69x.x1
F1	Pop Rivet, Aluminum 1/4"	901,100,43x.x1
F2	Drive Rivet, #38-108-06-13 1/4" dia.	901,100,44x.x1
F4	Pop Rivet, Black 1/8"	901,100,54x.x1
F5	Pop Rivet, Steel (Zinc Plated) 1/8" was 901,100,61x.x1	801,100,81x.x1
F6	Pop Rivet, Aluminum 1/8"	901,100,53x.x1
F7	Pop Rivet, Steel (Zinc Plated) 3/16" was 901,100,60x.x1	801,100,79x.x1
H1	Christmas Tree Clip #354280307-00	900,902,13x.x1
H2	Tinnerman Clip, Fan Shroud (C5207-014-3B) was 900,901,89x.x1	800,903,49x.x1
H3	Grommet, Bk. Rubber #97	900,401,09x.x1
H4	E-Ring #31-30	901,503,07x.x1
H5	Retainer, Roller Pin	900,900,90x.x1
H6	Tinnerman Clip	900,902,18x.x1
H7	Hole Plug, Snap in - 1 1/4	801,807,01x.x1
H8	Grommet, 5/16" Admiral #B53351	901,806,77x.x1
H9	Silencer	902,100,29x.x1
I1	#6 Terminal Ring Crimp 16-14 AWG	804,601,45x.x1
I2	Nylon Spacer .187 x .440 .093	801,902,48x.x1
I3	Velcro Blocks (Fastener, Dual Lock-Mated)	801,809,12x.x1
I4	Vender Defender Clamp	801,807,49x.x1

Part numbers & descriptions are subject to change with out notice.
 NA = Not applicable TBD = To be determined RB = Replaced by

WASHERS, BOLTS, & MISC. HARDWARE

ITEM	PART NAME AND DESCRIPTION	
15	Clamp, Cable 1" Heyco 3390	901,901,89x.x1
16	Clamp, Nylon 5/16" White Heyco 3555 or Dennison 10159 was 900,901,79x.x1	800,902,51x.x1
17	Clamp, Nylon 1/2" Heyco 3328	900,901,80x.x1
18	Hand Tie, 5.5"	901,901,06x.x1
19	Wire Tie, 7 1/2"	901,902,01x.x1
10	Wire Ties, 4"	901,901,00x.x1
11	Clamp, Nylon 3/4" Heyco 3382BL	901,900,55x.x1
12	Cable Tie, 5.5"	901,902,83x.x1
13	Canoe Clip #254-090-301-00-0108	900,902,14x.x1
Part numbers & descriptions are subject to change with out notice. NA = Not applicable TBD = To be determined RB = Replaced by		